

# Wildlife/Dangerous tree Assessor's Course Workbook

## Forest Activities Course Module



*An initiative of the:*  
Wildlife Dangerous Tree Committee of British Columbia  
*in cooperation with:*

WorksSafe BC



Ministry of Forests



Ministry of Environment &  
Climate Change Strategy



Updated April 2022

## **Library and Archives Canada Cataloguing in Publication**

**Wildlife/dangerous trees assessor's course workbook: Forest Activities course module / an initiative of the Wildlife Dangerous Tree Committee of British Columbia, in cooperation with WorkSafeBC ... [et al.]. – Rev. Oct. 2021**

**Co-issued by: Ministry of Forests, Lands, Natural Resource Operations & Rural Development, and the Ministry of Environment and Climate Change Strategy & Climate Change Strategy.**

**Cover title.**

**Electronic monograph in PDF format.**

**ISBN 978-0-7726-6191-3**

- 1. Tree hazard evaluation. 2. Wildlife trees—British Columbia—Identification. 3. Forest animals—Habitat—British Columbia. 4. Trees—Diseases and pests—British Columbia. 5. Forests and forestry—Environmental aspects—British Columbia. 6. Industrial safety—British Columbia. I. BC Parks II. British Columbia. Ministry of Environment and Climate Change Strategy III. Wildlife Dangerous Tree Committee of British Columbia (Canada) IV. British Columbia. Ministry of Forests. V. WorkSafeBC.**

**SD484.B74W54 2017**

**634.9'609711**

**C2010-900079-X**

### **DISCLAIMER**

**This publication is intended for use by clients of the Wildlife/Dangerous Tree Assessor's Course. Possession of such publication does not constitute an official endorsement or approval by the Government of British Columbia to offer service or gain profit. Only approved training courses can result in certification. The Wildlife Dangerous Tree Committee is not responsible for direct, indirect, special or consequential damages, however, caused, arising from the use of this document and its information.**

## **DANGEROUS TREE ASSESSMENT IN BRITISH COLUMBIA**

The Wildlife/Dangerous tree Assessor's Course (WDTAC) is recognized in British Columbia by the provincial Ministry of Forests, Ministry of Environment and Climate Change Strategy, and WorkSafe BC (Workers' Compensation Board), as the current "standard of care" (i.e., the best available and accepted standards and practices) for assessing dangerous trees and evaluating wildlife habitat value in forestry, non-urban park, and wildland fire situations. Three 2-day course modules exist for the WDTAC. These are:

- Forest Activities,
- Parks and Recreation Sites, and
- Wildland Fire Safety.

All of the above modules use the same technical criteria and standards for determining tree defect failure potential. However, they differ in specific safety procedures and related protocol for conducting and implementing dangerous tree assessments. For example, dangerous tree assessments are only valid for a period of 72 hours (dependent on burning conditions) under the Wildland Fire Safety Assessment module but are often valid for a season or more under the other assessment situations.

Anyone wishing to become a certified dangerous tree assessor in British Columbia for forestry, non-urban parks or wild land fires must demonstrate sufficient background knowledge or experience in one of these areas. They may then participate in one of the corresponding dangerous tree training modules. Upon successful completion of the course and exam, an individual will be certified to assess potentially dangerous trees in the area covered by the training module. However, because of the common technical criteria shared by all modules, it will be possible for persons to upgrade their certification from one module to another, provided they have the requisite experience in that field.



The technical criteria used to evaluate tree hazards, as taught in the above modules, may be adaptable to other situations including recreational wooded areas such as golf courses and ski hills, urban parks and “natural areas”, and utility corridors. However, any adaptations must be done with caution. The WDTAC was developed for non-urban environments based on native conifer species and selected native hardwoods. In these types of environments, where both public and worker safety, as well as various public values such as aesthetics are an issue, there is greater expectation to balance the technical standard of care with concepts of due diligence, risk management and liability. **Consequently, assessors are cautioned to apply the WDTAC process only to the circumstances and tree species for which they are trained and familiar.**

Doug Lewis  
*Ministry of FLNRORD*

Mike Nielsen  
*WorkSafe BC*

Lindsay Vandesteeg  
*Ministry of Environment &  
Climate Change Strategy*

## ACKNOWLEDGEMENTS

Many individuals and organizations have contributed time and expertise to this project. The Wildlife Tree Committee would like to thank the many people who reviewed the workbook in its different stages of development.

The following people are responsible for this edition of the course workbook: Doug Lewis (Resource Practices Branch, Ministry of Forests, Lands and Natural Resource Operations); and Lindsay Vandesteeg (BC Parks and Protected Areas Branch, Ministry of Environment and Climate Change Strategy); Mike Nielsen and Budd Philipps (WorkSafe BC); and Dean McGeough (Integra Forest Consulting Ltd.). Final technical edits were conducted by Dean McGeough.

The following course instructors have made invaluable contributions to course materials over the years: Todd Manning, Doug Ellis, Fred Marshall, Dean McGeough, Bill Golding, Michael Shepard, Jerry Benner, Jack Verschoor and Gary Collett.

Illustrations are by Mark Nyhof, Soren Henrich and Bill Adams. Photographs were provided by Bill Beese, Brinkman and Associates, Doug Ellis, Tom Hedekar, Jared Hobbs, Todd Manning, Duncan Morrison, Bruce Morrow, Dean McGeough, BC Ministry of Environment and Climate Change Strategy, Ministry of FLNRORD, Natural Resources Canada, and the Canadian Association of Geophysical Contractors.

## CONTENTS

Preface .....	iii
Acknowledgements .....	iv
Contents .....	v
What is the Wildlife Dangerous Tree Committee of British Columbia? .....	vii
Memorandum of Understanding Concerning Wildlife and Dangerous Trees .....	ix
Course Background .....	xii
Goals and Objectives .....	xiii
Agenda: Wildlife/Dangerous Tree Assessor's Course .....	xiv
<b>Section One: Introduction to Wildlife Trees .....</b>	<b>1</b>
What is a Wildlife Tree? .....	3
What Constitutes Good Wildlife Tree Habitat? .....	7
Wildlife Trees and the Process of Tree Death and Decay .....	11
Coarse Woody Debris .....	15
Wildlife Tree Classification System for B.C. ....	17
The Importance of Wildlife Trees .....	21
The Ecological and Economic Significance of Wildlife Tree Users .....	27
<b>Section Two: Wildlife/Dangerous tree Assessment – Terms of Reference .....</b>	<b>35</b>
What is a Dangerous Tree? .....	36
Determining Tree Danger Rating .....	36
Summary of Assessment Requirements .....	55
No-work Zones (NWZ) .....	59
<b>Tables</b>	
1. Levels of disturbance for unprotected workers in various work activities ....	38
1A. Influence of wind speed on level of disturbance 1B. Helicopter types .....	39
2. Site Assessment Overview (for all tree species) .....	40
3. Dangerous Tree Assessment Process for Level 1 Disturbance Activities— Significant Hazard Indicators .....	49
4. Dangerous Tree Criteria for Level 2 Disturbance Activities .....	51
4A. Dangerous Tree Criteria for Level 3 Disturbance Activities .....	52
5. Dangerous Tree Assessment Process for Level 4 Disturbance Activities ...	54
References .....	73
Glossary .....	76
<b>Appendices</b>	
1. Some Important Tree Pathogens in B.C. Forests .....	83
2. Users of Wildlife Trees and Level Of Dependency .....	95
3. Dangerous Tree Management in Preparation for Silviculture Activities .....	99
4. Pertinent Regulations .....	103
5. A Discussion of Liability and Dangerous Tree Assessment .....	107
6. Dangerous Tree Assessment Field Data Forms .....	109
7. Field Procedure Guides .....	113



## WHAT IS THE WILDLIFE TREE COMMITTEE OF BRITISH COLUMBIA?

The Wildlife Tree Committee (WTC) is a multi-agency committee composed of representatives from the provincial Ministry of Forests, the Ministry of Environment and Climate Change Strategy, the WorkSafe BC, industry and labour, and public interest groups from across the province. Formed in 1985, the WTC is the advisory body acting on behalf of the three signatory agencies and representing all wildlife tree matters in British Columbia.

The Wildlife Tree Committee mandate is:

**To promote the conservation of wildlife trees and associated stand-level biodiversity in a safe and operationally efficient manner, in forest, park and urban environments.**

Two major objectives of the WTC are:

- to ensure the maintenance and enhancement of wildlife trees in order to sustain the species dependent on them (about 80 species, or 15% of the province's birds, mammals, and amphibians); and
- to foster cooperation and understanding between the various interest groups.

The WTC believes that managed forests, high standards of worker safety, and maintenance of valuable habitat for wildlife tree-dependent species are mutually compatible if cooperative action is taken to integrate these goals.



# MEMORANDUM OF UNDERSTANDING

## In Regards To

### Wildlife Dangerous Tree Committee of British Columbia

BETWEEN:

HER MAJESTY THE QUEEN IN RIGHT OF THE PROVINCE OF BRITISH COLUMBIA acting through;  
the Ministry of Forests, Lands, Natural Resource Operations & Rural Development as represented by the Resource Stewardship Division and the Integrated Resource Operations Division

the Ministry of Environment and Climate Change Strategy & Climate Change Strategy as represented by Environmental Sustainability and Strategic Policy Division and the BC Parks and Conservation Officer Service Division

AND:

The Workers' Compensation Board of British Columbia

**(Collectively referred to as the "Parties")**

The Parties to this Memorandum agree as follows:

#### **SECTION 1 - BACKGROUND**

The Wildlife Dangerous Tree Committee ("WDTC") is a multi-agency committee composed of representatives from the Ministry of Forests, the Ministry of Environment and Climate Change Strategy & Climate Change Strategy, and the Workers' Compensation Board of British Columbia. Formed in 1985, the WDTC is the advisory body acting on behalf of the three Parties and represents wildlife tree matters in British Columbia. The mandate of the WDTC is:

*To promote the conservation of native wildlife trees and associated stand-level biodiversity in a safe and operationally efficient manner in forest and park environments.*

The Wildlife Dangerous Tree Assessor's Course and related materials is an important means of implementing the mandate of the WDTC.



## SECTION 2 - DEFINITIONS

### 2.1 Where used in this Agreement

- (a) "MOU" means Memorandum of Understanding.
- (b) "MoF" means means former Ministry of Forests, Lands, Natural Resource Operations & Rural Development (MFLNRORD)
- (c) "MOE" means Ministry of Environment and Climate Change Strategy & Climate Change Strategy
- (d) "WorkSafeBC" means Workers' Compensation Board of British Columbia
- (e) "WDTA" means Wildlife Dangerous Tree Committee of British Columbia
- (f) "WDTAC" means Wildlife Dangerous Tree Assessor's Course
- (g) "Wildlife tree" means a tree that provides wildlife habitat
- (h) "Dangerous tree" means a tree that is a hazard to a worker as defined in the *Operational Health and Safety Regulation* section 26.1. A "dangerous tree" is synonymous with "dangerous tree" for the purposes of this MOU. A dangerous tree may also be a wildlife tree.

## SECTION 3 - PURPOSE AND EXPECTED RESULTS

The WDTA works to ensure the safe maintenance and enhancement of native wildlife trees in order to sustain the species dependent on them. An important component of this work is to foster cooperation and understanding of stakeholder groups involved in resource management involving wildlife and dangerous tree management. The WDTA believes that managed forests, high standards of worker safety and maintenance of valuable habitat for wildlife tree dependent species are mutually compatible with cooperative action to integrate these goals.

The safe management of wildlife trees in forestry operations is mandated through WorkSafeBC's legislative framework. Management of stand-level biodiversity is part of the legislative framework of MoF and MOE. This MOU defines each agency's role and responsibilities concerning the management of wildlife trees in terms of safety and maintenance of biodiversity.

### 3.1 Purpose

Acknowledge the importance of a multi-agency committee to oversee safe management of native wildlife trees in forest work settings.

### 3.2 **Expected Results**

Allow for ongoing time and resource commitment for representatives of the WTC to continue the mandate of the committee, including staff time to attend committee meetings and work on necessary actions arising from the meetings.

## **SECTION 4 - ROLES AND RESPONSIBILITIES**

### 4.1 WorkSafeBC agrees to:

- (a) Ensure that workplace health and safety concerns associated with the planning, management and/or field assessment of wildlife dangerous trees are covered in the training courses and reference materials on wildlife tree management and related habitat management concepts (e.g., WDTAC).
- (b) Support forestry techniques and other policies, directives, or practices, that can be safely implemented, while managing and retaining wildlife trees and other stand structural attributes.
- (c) Coordinate with all members of the WDTAC on the efficient administration of certification and training for wildlife dangerous tree assessors through the various modules of the WDTAC.

### 4.2 The MOE agrees to:

- (a) Ensure the habitat concerns associated with the planning, management and/or field assessment of wildlife/dangerous trees are covered in the training courses and extension materials on wildlife tree management and related habitat management concepts (e.g., WDTAC).
- (b) Coordinate with all members of the WDTAC on the efficient administration of certification and training for wildlife dangerous tree assessors through the various modules of the WDTAC.
- (c) Provide lead technical advice for assessment of wildlife dangerous trees in natural park situations and course materials for the Park and Recreation Sites module of the WDTAC.

### 4.3 The FLNRORD agrees to:

- (a) Ensure both the stewardship and operational safety concerns, associated with the planning, management and/or field assessment of wildlife dangerous trees, are covered in the training courses.
- (b) Coordinate with all members of the WDTAC on the efficient administration of certification and training for wildlife dangerous tree assessors through the various modules of the WDTAC.
- (c) Provide lead technical advice for assessment of wildlife dangerous trees in Forest Operations situations (WDTAC Forest Operations) and in wildfire management situations (WDTAC Wildland Fire Safety module).
- (d) Maintain a WDTAC webpage on the FLNRORD website.

### 4.4 The Parties agree to work together to support and improve the wildlife dangerous tree assessment process and training.

## COURSE BACKGROUND

This module is intended for those who work around potentially dangerous trees in forest activities, which can include activities associated with timber harvesting, silviculture, geophysical exploration, pipeline construction, post-fire rehabilitation and roadside.

Those participants wishing to become qualified assessors require:

- *Three or more years of practical field experience in the area of forestry, resource management, parks management, wildland fire protection, arboriculture, geophysical exploration or a related field; and*
- *Grade 10 equivalency in reading, writing and arithmetic skills (including the ability to calculate percentages); and*
- *Ability to identify tree species native to BC; and*
- *Proven forestry measurement skills (including ability to determine tree diameter, height, lean, stem cross-section, and skill in distance measuring).*

In order to receive a qualifying certificate, students must pass a certifying exam (written and field practical with combined 75% average, including minimum 85% on field practical exam).

The course will be offered on an ongoing basis throughout British Columbia to:

- WCB field inspectors;
- foresters, forestry technicians, and others involved in Site Plan and Forest Stewardship Plan preparation, cutblock and seismic line engineering and layout, timber harvesting and silviculture activities, pipeline construction and land clearing activities;
- fallers, logging supervisors, oil and gas project supervisors and other forestry workers.

Certified assessors in BC will be recognized by WorkSafe BC, MoF, MOE and Energy Safety Canada.

On successful completion of the 2-day course, the certified assessor will be competent in the following:

- identifying important attributes of wildlife/dangerous trees;
- assessing trees for their potential as wildlife habitat;
- assessing trees for their failure potential;
- making appropriate safety decisions regarding assessed trees.

## COURSE GOALS AND OBJECTIVES

### Goals

The goal of the **Wildlife/Dangerous Tree Assessor's Course** is to present information, practical field experiences and methods for:

- developing wildlife tree and dangerous tree identification procedures;
- retaining selected wildlife tree habitat; and
- maintaining a safe work environment.

### Objectives

Participants in the **Wildlife/Dangerous Tree Assessor's Course** will be trained to:

- **recognize existing and potential wildlife trees**, identify wildlife tree use, and understand the importance of wildlife trees and how to integrate them into operational forest management; and
- distinguish between safe and dangerous trees, thereby enabling them to **determine tree hazards and related safe work procedures appropriate for dealing with wildlife and dangerous trees in various forest activities.**

### NOTES:

---

---

---

---

---

---

---

---

---

---

## AGENDA WILDLIFE/DANGEROUS TREE ASSESSOR'S COURSE

(Schedule may vary depending on audience and location of field sites, and instructor needs)

### DAY 1

8:00 a.m.	Welcome participants Introduce instructors and participants
8:20 a.m.	Introduction to wildlife trees <ul style="list-style-type: none"><li>• what is a wildlife tree?</li><li>• wildlife tree habitat</li><li>• pathology of wildlife trees</li><li>• wildlife tree classification</li><li>• importance of wildlife trees</li><li>• ecological significance of wildlife trees</li></ul>
9:45 a.m.	Coffee break
10:00 a.m.	Wildlife/dangerous tree assessment <ul style="list-style-type: none"><li>• worker safety—what is a dangerous tree</li><li>• relevant WCB regulations</li><li>• level of disturbance</li><li>• site overview</li><li>• visual tree inspection</li><li>• detailed tree assessment</li><li>• overall tree danger rating</li><li>• safety procedures</li></ul>
12:00 noon	Lunch
1:00 p.m.	Wildlife/dangerous tree field assessment—individual trees <ul style="list-style-type: none"><li>• participants will assess wildlife/dangerous trees for hazards, soundness and wildlife habitat value. Participants will carry out practical field identification and determine tree danger ratings and safety procedures for various trees</li></ul>
4:30 p.m.	Adjourn Day 1

## DAY 2

8:00 a.m.	Discuss homework; review management of wildlife/dangerous trees under various forest operation scenarios (along roads and seismic lines, silviculture, timber harvesting, pipeline construction, high stem density); alternate work procedures for trembling aspen
10:30 a.m.	End of Classroom training session; commence examination process – written exam
12:00 p.m.	Lunch Break
12:30 p.m.	Continues Examination process – field practicum
4:30 p.m.	Course concludes

(Schedule may vary depending on audience and location of field sites, and instructor needs)

### Materials Required

**All necessary classroom materials will be supplied by the instructor.**

**The participant is responsible for providing the following essential items for field exercises:**

- personal gear, including rain gear (mandatory)
- hardhat (mandatory)
- boots with ankle support (mandatory; caulk boots recommended for coastal locations)
- binoculars (recommended)
- clinometer and compass (recommended)
- increment borer (recommended)
- diameter tape or carpenter tape (recommended)
- probing instrument (mandatory; e.g., pocket knife, screwdriver)
- 6-ring field notebook and pencils (mandatory)

**NOTES:**

---

---

---

---

---

---

---

---

---

---





## Section One

### INTRODUCTION TO WILDLIFE TREES

#### Learning Objectives

- What is a Wildlife Tree?
- What Constitutes Good Wildlife Tree Habitat?
- Wildlife Trees and the Process of Tree Death and Decay
- Wildlife Tree Classification System
- The Importance of Wildlife Trees
- The Ecological and Economic Significance of Wildlife Tree Users
- Determining Wildlife Tree Value

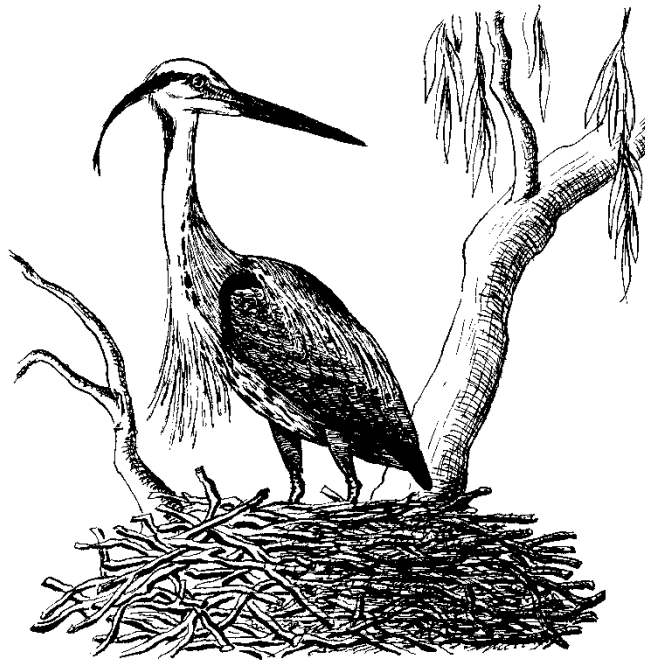



## WHAT IS A WILDLIFE TREE?

Trees in various stages of life, death and decay are important components of the structure and function of all natural forest ecosystems. Wildlife trees are part of this cycle of life and death. They are constantly being formed by biotic and abiotic factors such as insects, fungi, fire and weather.

***A wildlife tree is any standing dead or live tree with special characteristics that provide valuable habitat for the conservation or enhancement of wildlife.***

It can take decades, even centuries, for a tree to complete the cycle of germination, maturation and decay. Careful assessment and conservation of wildlife trees during harvesting and silviculture operations help to ensure continued existence of wildlife trees in managed forests.

The value of any particular tree as wildlife habitat depends on a variety of attributes, including structure, age, condition, abundance, species, geographic location and surrounding habitat features.

Rapid death by fire produces a different kind of wildlife tree than gradual death by insects or disease. Forest health agents such as these create most of the wildlife trees in the forest. Local climate and tree species also influence the way a tree deteriorates and decays.

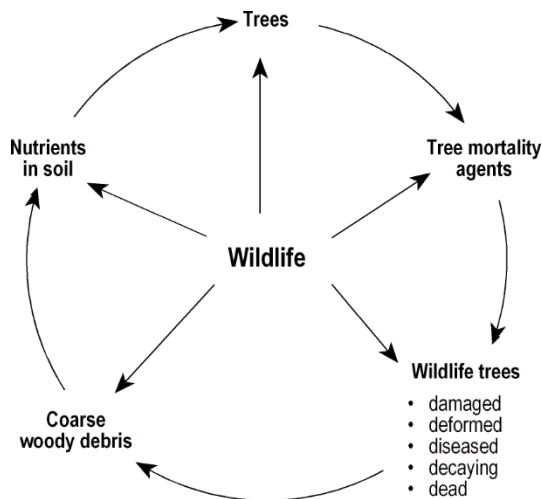
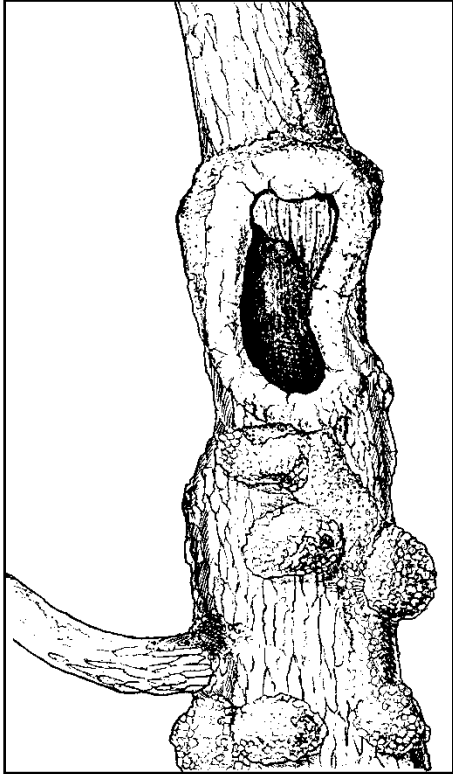

Figure 1. Interaction between wildlife and trees.

There are many habitat features associated with wildlife trees. They are created or caused by influences such as animal excavations, disease, insect attacks, wind, snow and lightning. More than 80 species of vertebrates and countless invertebrates depend on these habitat features for part of their livelihood. Twelve examples of habitat features to be found in wildlife trees are shown on the following pages.

## Habitat Features in Wildlife Trees



Natural cavity in bigleaf maple.

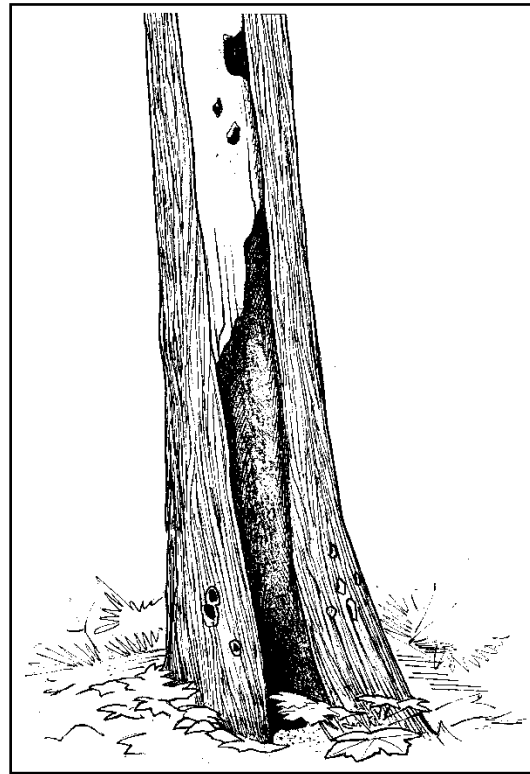

"Chimney effect" in western redcedar (a bat tree).

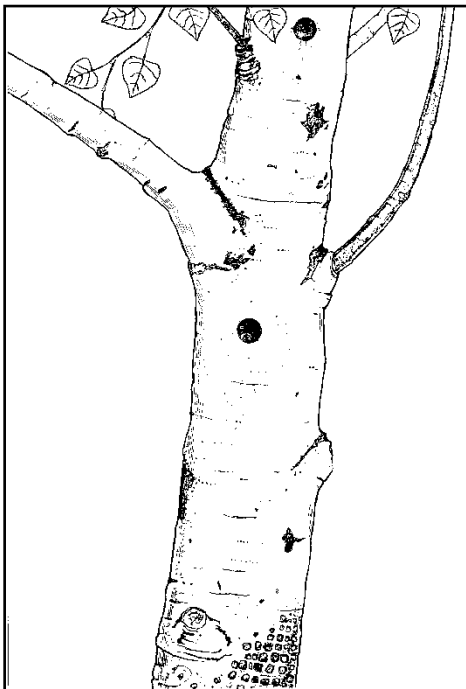

Live hardwood with primary cavity excavation and sapsucker feeding.

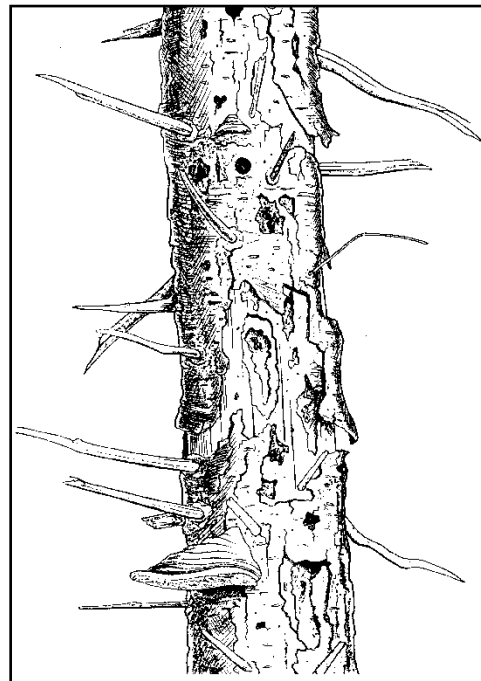

Heart rot and loose bark, (used by birds such as Brown Creepers and nuthatches).

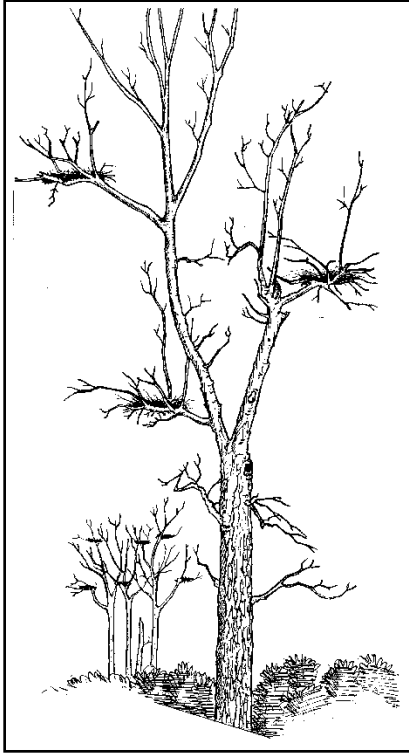

*Branching in black cottonwood (nesting for Great Blue Heron).*

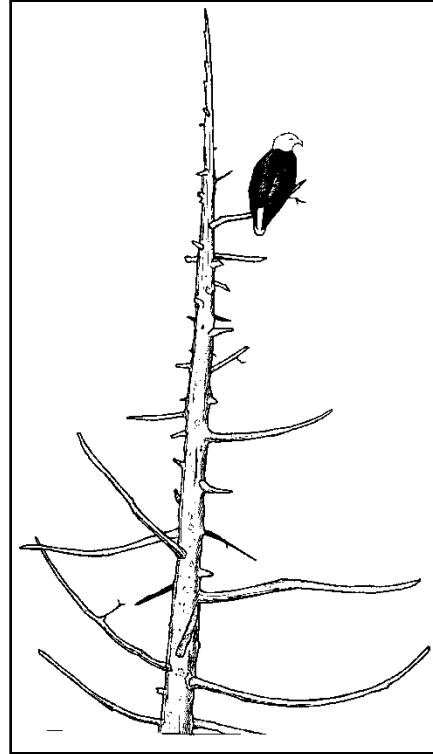

*Spike top snag (for perching birds such as Bald Eagle).*

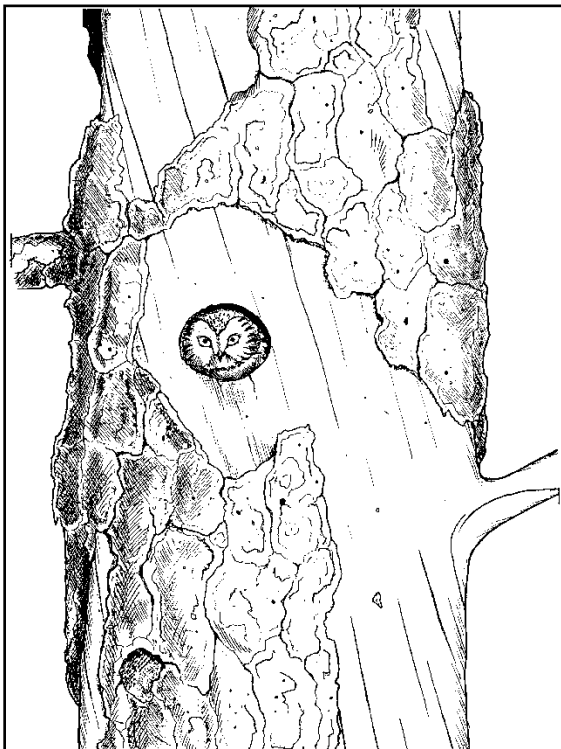

*Secondary cavity in ponderosa pine (Saw-whet Owl using old Northern Flicker cavity).*

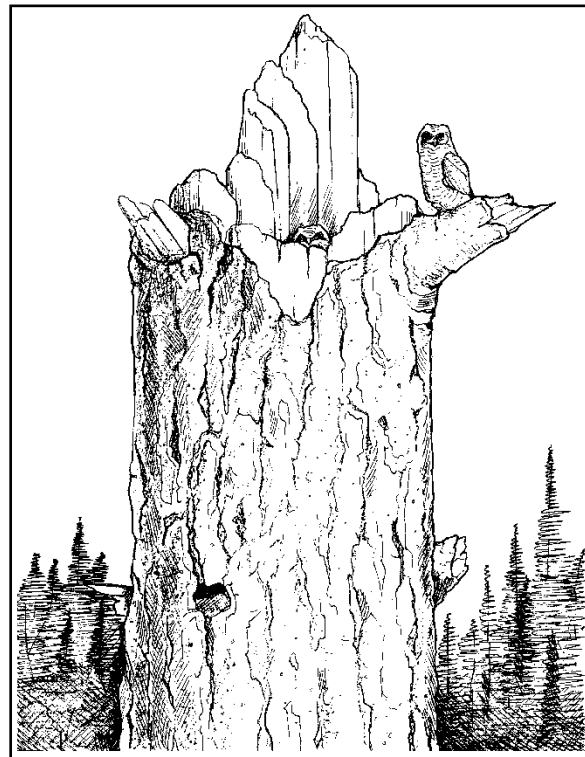

*Douglas-fir snag (nesting and perching for owls).*

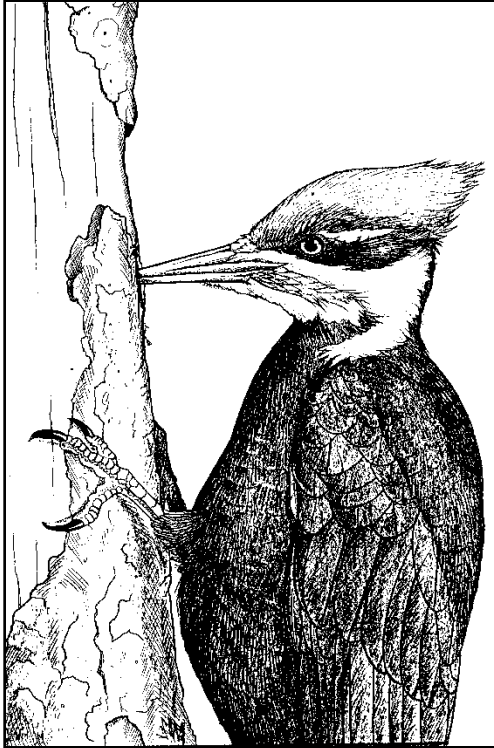

*Pileated Woodpecker excavating for insects.*

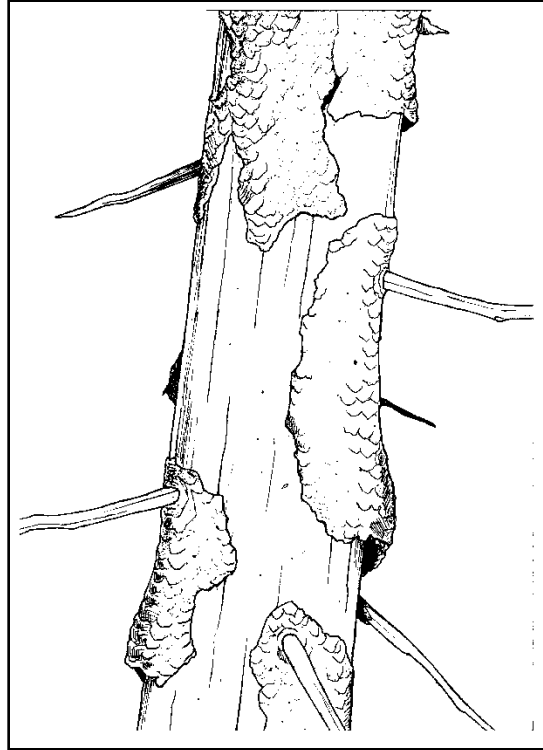

*Loose bark suitable for a bat roost.*

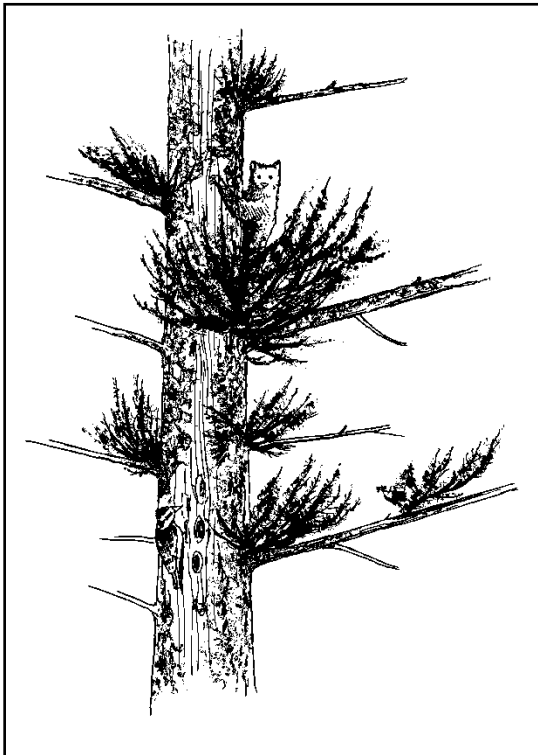

*Witches' broom (habitat for marten and other wildlife tree users).*

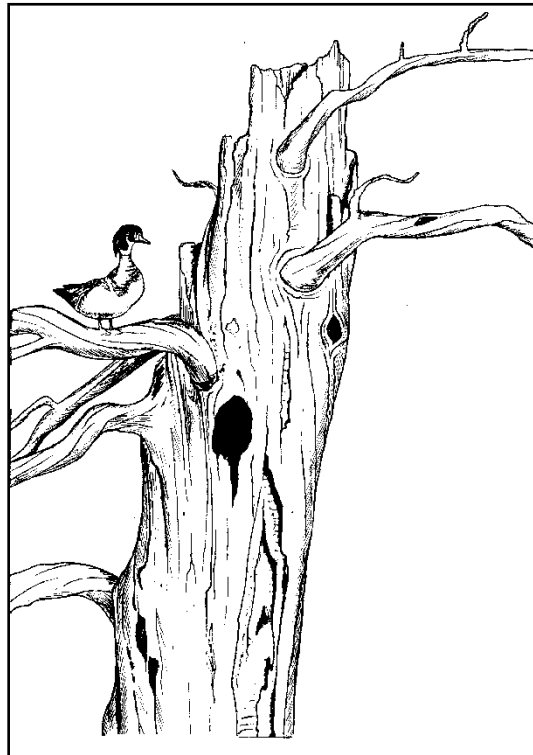

*Wood Duck at enlarged cavity in dead ponderosa pine.*

## WHAT CONSTITUTES GOOD WILDLIFE TREE HABITAT?

When considering the needs of wildlife, it is important to recognize that all trees are not equal in value. Given the large number of wildlife tree-dependent species and wide range of wildlife uses of these trees, there can be no simple system for determining which trees provide the best habitat for wildlife. The most significant indicators of wildlife tree quality are height and diameter, decay stage, location, distribution and cause of death.

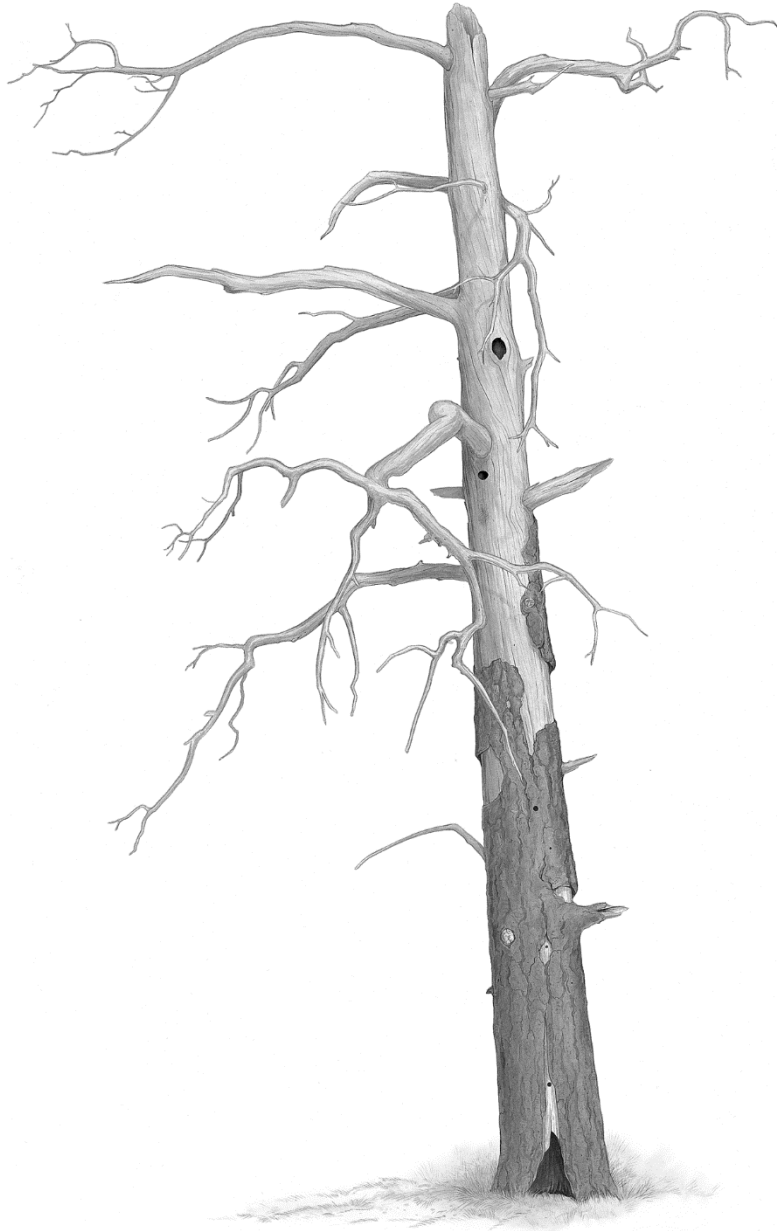

### **Wildlife Tree Characteristics:**

- greater than 15 m in height is preferable
- greater than 30 cm dbh is preferable (interior)
- greater than 70 cm dbh is preferable (coastal)
- tree classes 2–6 most valuable
- windfirm, sound root system
- broken top
- some large branches
- some intact bark with space behind loose bark
- nest cavities, feeding excavations
- some evidence of decay (visible fungal conks or open cavity)

**NOTE:** dbh = diameter at breast height (1.3m above root collar)

## Height and diameter

Generally, the larger the diameter of a wildlife tree, the greater the variety of species that benefit from it. Most wildlife tree-dependent species prefer tall, larger diameter trees because they offer greater security. A tree with a large trunk provides the potential for a spacious cavity with strong walls. Thick-walled cavities protect their occupants against predators and inclement weather. Large dead trees usually remain standing for many years, providing wildlife habitat for a much longer time than small trees, which fall soon after they die. Large trees are also important for open nesters such as Bald Eagles, Ospreys, and some hawks and owls.

## Decay stage

Each stage in the decay process has particular value to certain wildlife species. The earlier the stage of decay, the harder the wood will be. Strong excavators (woodpeckers) usually nest and roost in “hard” trees, while weak excavators (nuthatches, chickadees) prefer “soft” trees. Soft trees also provide the substrate for the numerous species of invertebrates that comprise the food supply of many wildlife species. “Hard” trees which still have branches provide good hunting perches for predatory birds. They also have great future value since most of them, except for those that are fire hardened, will eventually become soft. Fire hardened wildlife trees are not usually suitable for excavating nest holes, but they are often good feeding and perching sites, especially in the first 1–2 years after the fire.

## Location

Animals that require dead trees for nesting, denning or feeding usually need live trees nearby for protective cover and foraging habitat. Nest trees of primary cavity excavators (PCEs) are often found at the edge of cutblocks, roads or natural forest openings. The species composition and structure of the surrounding plant community also influence wildlife use of trees. Some wildlife species such as kestrels, flycatchers and bluebirds require trees surrounded by low or early-seral vegetation (grass-forb, shrub-seedling, pole-sapling) which can function as hunting perches and harbour prey species. Woodpeckers, owls, Vaux's Swifts and others are dependent on the taller tree communities that develop later (young, mature or old-growth). Wildlife trees adjacent to water bodies are important for cavity-nesting ducks, Great Blue Herons, Ospreys, Bald Eagles and Belted Kingfishers. The preferred topographic location of roost trees may vary from season to season.



## Determining wildlife tree value

Generally, the following characteristics indicate the relative habitat value of a wildlife tree for a recreation site or worksite.

Wildlife Tree Value	Characteristics
<p><b>HIGH</b></p> <p>NOTE: If a tree has an active nest then automatically default to high value, regardless of tree size.</p> <p>Culturally Modified Trees (CMT's) and Special Trees (defined by regulation) are also to be regarded as High Value.</p>	<ul style="list-style-type: none"> <li>• A tree with rare or uncommon habitat characteristics for the site. (e.g., large brooms, cavities, loose bark, dead tops, broken tops, perch site)</li> <li>• A tree protected by policy or special management practices (e.g., CMT, Special Tree, monumental trees, veteran trees, etc)</li> <li>• Tree with active or recent wildlife use (feeding, nesting, denning, perching, roosting, etc)</li> <li>• Tree structure suitable for wildlife use (suitable for large stick nest, hunting perch sites, bear den, fisher den, etc.)</li> <li>• Largest tree for site (height and/or diameter) or rare tree species</li> <li>• Habitat characteristics suited for locally important wildlife tree user species</li> </ul>
<b>MEDIUM</b>	<ul style="list-style-type: none"> <li>• Large, stable trees that will likely develop into a wildlife tree (e.g., recent split, broken top, death from insects)</li> <li>• A wildlife tree that has deteriorated and has diminishing viability for continued use</li> </ul>
<b>LOW</b>	<ul style="list-style-type: none"> <li>• Trees not covered by high or medium categories</li> <li>• Trees which are highly unstable and unlikely to remain standing beyond an operational period (e.g., advanced root disease, leaners, soft wood decay class)</li> </ul>

Note: Under section 34 of the Wildlife Act, no tree with an active nest, or the nest of an eagle, peregrine falcon, gyrfalcon, osprey, heron can be disturbed.

## Most valuable wildlife tree species

Because of natural variations in size, growth form and habit, and decay characteristics, some native tree species are inherently more valuable as wildlife trees than others. The following is a **generalized ranking of habitat value** (i.e., 1 = most valuable) for some common native tree species. However, this order may vary depending on site and tree-specific conditions (e.g., presence of pathogens, relative abundance tree species, condition of trees in the local area, location or proximity to other habitats such as riparian areas, etc).

1. Douglas-fir and western larch
2. ponderosa pine
3. trembling aspen and cottonwood
4. cedars (which have large hollow cavities)
5. hemlocks and true firs (these species have better short-term habitat value)

## Distribution and Tree Mortality

Wildlife trees are not evenly distributed throughout the forest. They are often found in patches corresponding to the unpredictable nature of tree mortality causes such as insect pests, diseases or wildfire. These forest health factors are often interrelated and play important roles in the ecology of wildlife trees. Root diseases, for example, predispose trees to infestations by insects and/or heart rots, thereby creating suitable nesting and feeding habitat for many wildlife species. Similarly, fire-damaged or fire-killed trees are often attacked by wood-boring beetles or flying insects which subsequently become a food source for woodpeckers, bats and other wildlife tree users.

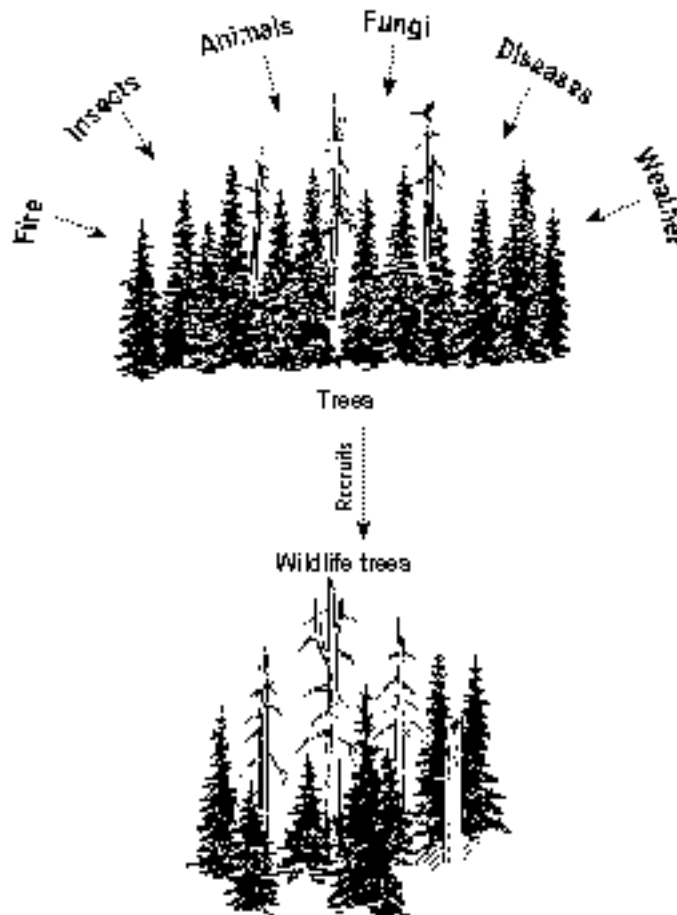

Figure 2. Tree mortality agents.

## WILDLIFE TREES AND THE PROCESS OF TREE DEATH AND DECAY

Decay and the associated deterioration and death of trees are normal processes that regularly occur within forested ecosystems and are partly responsible for the ever-changing nature of forests. Casual observation may suggest that, aside from obvious factors such as fires and insect attacks, trees die randomly. However, a closer look reveals that tree death is a complex process. The timing and rate of death depend on several factors, including but not limited to:

- A. **The tree species:** Some trees, such as hardwoods, often succumb to pathogens at a relatively early age (i.e., 50–60 years).
- B. **The location of the tree relative to site and biogeoclimatic zone:** Trees located near the edge of their normal range are less resistant to pest attacks than those situated well within their normal range. Trees located on harsh sites are more easily stressed and hence more susceptible to attacks by various pests.
- C. **The age, health and vigor of the host tree:** Trees are most susceptible to injury and attack when they are very young, very old, or otherwise unhealthy or stressed.
- D. **The pest species:** Most pests favour certain host tree species and have little or no effect on other species.



*Canker (Atropellis spp) on pine. An obligate pathogen, the canker fungus derives its nutrition by killing host tissue.*



*White Mottled Rot (Ganoderma applanatum), a heart rot fungus common on hardwoods.*

**E. The amount or numbers of the pest present and its virulence:** Successful attack resulting in significant injury or death almost always requires that the attacking agent be quite strong and/or numerous in order to overcome the natural defenses of the host tree.

Plants can die either in whole or in part. It is common to see forest trees with dead tops, branches, or roots. Tree death can occur slowly or relatively quickly, as with insect attacks. Different mortality processes produce different types of wildlife trees and change the forest in different ways.

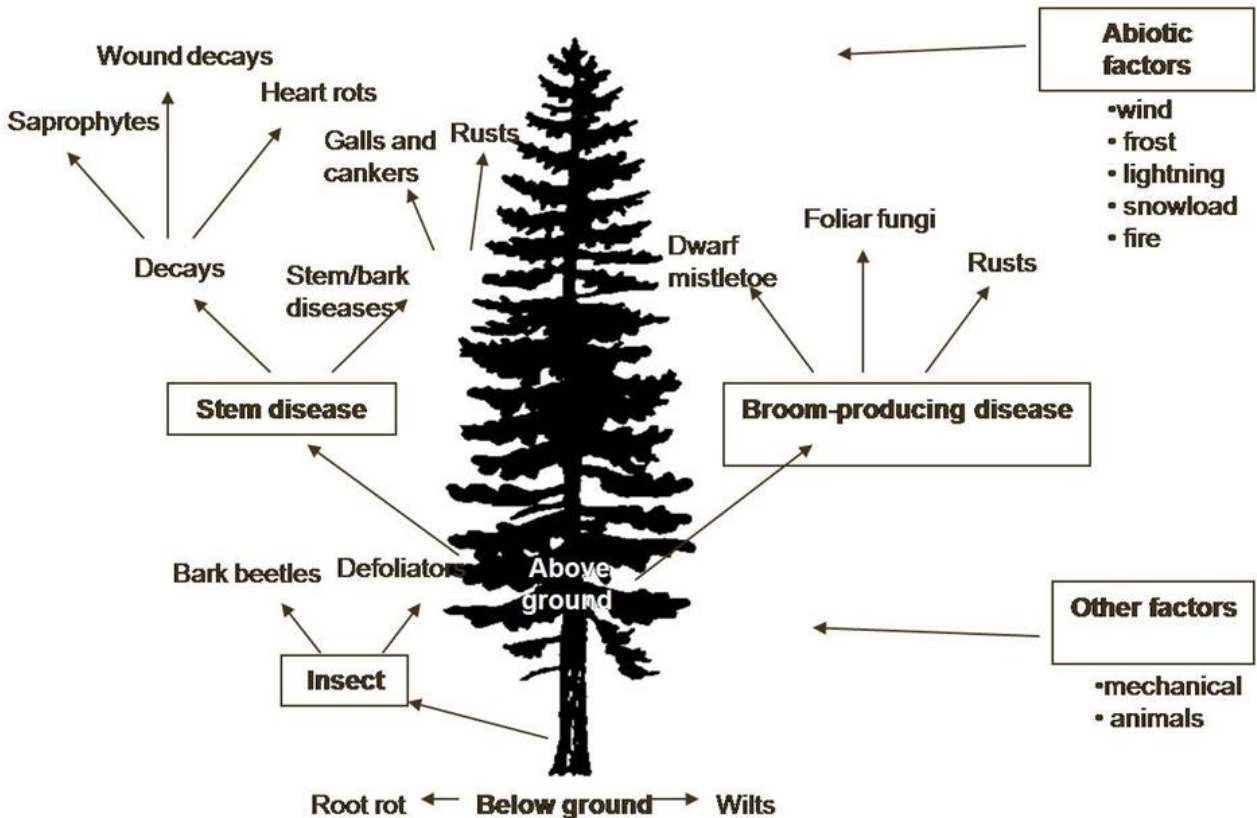

## Simultaneous and Cumulative Pest Attacks

Often several agents simultaneously attack, weaken and ultimately kill a single tree, a small group of trees, or even an entire stand of trees. At other times the mortality agents occur sequentially and act in an additive manner.

One possible scenario of mortality agents acting sequentially begins with a low intensity forest fire creating a large basal scar on a western larch tree. This scar is subsequently attacked and infected by a decay organism that causes heart rot. After several years the decay has traveled up the trunk of the tree. A heavy snowfall accompanied by high winds causes the trunk of the tree to break off at the 12-meter point. If there are no live limbs below the breakage, the tree is killed. In this example, fire, followed by decay, followed by adverse weather conditions, combined to kill the tree.

## Significance of Disease and Decay in our Forests

Virtually all natural tree mortality can be attributed to three broad categories: fire, insects and disease (the latter includes losses due to adverse climatic conditions and pollution). The estimated percentages attributable to each of these categories in B.C. are:

Fire	15%
Insects	20%
Disease	65%

Volume losses associated with these three categories are very large and may vary from 26 to 40 million cubic meters of timber per year. Relative to a current allowable annual timber harvest of approximately 70 million cubic meters, this amount is significant.

We can further refine and attribute the growth and mortality losses due to disease as follows (Source: Allan Van Sickle, Canadian Forest Service, Victoria, 1994):

Type of Disease	% of Volume Loss
Butt and heart rots	65
Dwarf mistletoes	9
Root rots	26
Total	100

As shown above, the most significant volume losses due to disease are attributable to decay organisms (91% of the total). However, not all of these losses are necessarily negative. What constitutes a healthy forest depends on one's viewpoint, and definitions of healthy and unhealthy are human perspectives.

### Some negative aspects of losses due to decay

1. Decay causes significant timber losses each year, resulting in large economic losses due to foregone harvesting and lumber processing opportunities.
2. Weak or unhealthy trees are often knocked over or broken off by wind or heavy snow. Such events sometimes cause damage to homes or powerlines and may result in human injury or death.
3. Dead or dying trees are susceptible to insect attacks and may act as brood trees for small insect populations allowing them to build up to epidemic levels which subsequently cause widespread forest damage.

### Some positive aspects of fungi in our forests.

1. Fungi are decomposers. They break down organic matter and thereby serve as important agents in nutrient cycling. They also reduce fire hazard by breaking down slash and other woody debris.
2. Decay fungi soften wood thereby rendering otherwise inhospitable trees more 'user friendly' to many species of birds and animals. In other words, they are very important agents in producing and developing what we now refer to as wildlife trees. Host trees with softened heartwood are more vulnerable and accessible to primary excavators, such as large woodpeckers, which create cavities for nesting. Once cavities are created, they are available over many years for other species of birds and mammals to use.
3. Many fungi, often referred to as ectomycorrhizae, live on the outer surface of tree roots and assist trees in absorbing nutrients from the surrounding soil.



Note: Additional information on tree pathogens can be found in Appendix 1.

*Blister rust fungus (Cronartium spp) on White pine.*

## COARSE WOODY DEBRIS

Coarse woody debris (CWD) provides:

- feeding, breeding, and shelter substrate for many organisms (invertebrates, small mammals, amphibians)
- nutrient source and growing substrates for various bacteria and fungi (including beneficial mycorrhizae fungi), as well as saprophytic plants, lichens and mosses that are important in decay, nitrogen production, and other nutrient and moisture cycling
- carbon storage
- erosion control
- buffered microclimates suitable for seedling establishment
- escape cover from predators
- shelter and access routes for small mammals in periods of heavy snow cover.

CWD also shapes and stabilizes stream banks, and in aquatic habitats it increases channel complexity and habitat quality by creating pools and riffles (disperse stream energy and create fish habitats.)

In streams, CWD increases litter fall retention (up to 70%), which is then decomposed by stream organisms.

Log decomposition stages are shown below.

*Spaces behind loose bark and amongst rotting wood fibre are habitat for salamanders*

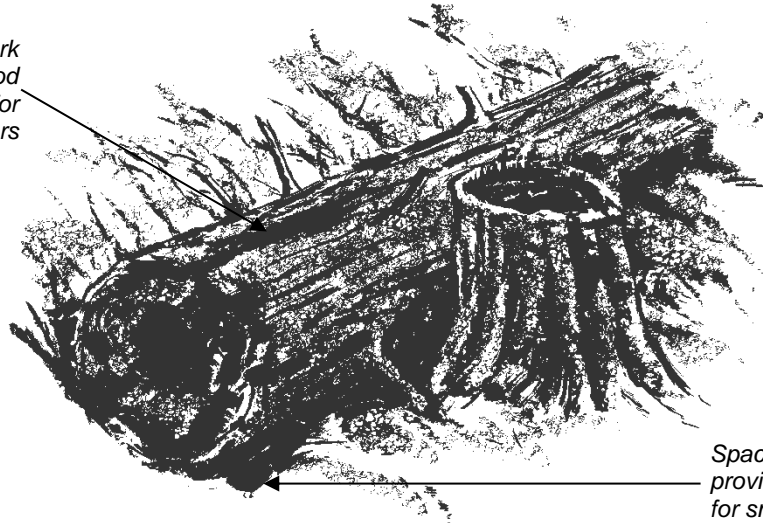

*Spaces under fallen logs provide sheltered habitats for small mammals*

<b>Log class 1</b>	<b>Log class 2</b>	<b>Log class 3</b>	<b>Log class 4</b>	<b>Log class 5</b>
<b>Internal succession</b>				

*Successional stages of decomposition in logs (source, Bartels et al. 1985).*





## WILDLIFE TREE CLASSIFICATION SYSTEM FOR B.C.

The Wildlife/Dangerous tree classification system used in B.C. describes each class of wildlife tree in several ways. This includes a simple, general description of each class, a list of the wildlife uses associated with that class, and a summary of the decay characteristics. Although this classification system is based on the decay pattern of thick-barked conifers, such as Douglas-fir and ponderosa pine, it is broadly applicable to all British Columbia native trees (conifers and broad-leaved deciduous).

The deterioration and decay processes occur in various stages, corresponding to the tree classes described below. Conifers can have up to 9 tree classes; whereas deciduous trees have 6 classes, reflecting their accelerated decay and fall-down rates as compared to conifers.

**Class 1: These are live, healthy trees with NO structural defects or injuries that have associated decay and which could compromise the structural strength of the tree.** Some live trees may show signs of deterioration or slight damage, such as dead branches, sound live forked or secondary tops, or minor physical injuries (e.g., healed-over stem scrapes). In most cases, these DO NOT have associated decay that might compromise the tree's structural strength.

**Class 2: These are live trees, but have some VISIBLE EXTERNAL DEFECT that can affect the tree's structural strength or introduce decay.** The first stages of deterioration often begin while the tree is still alive. Fungi or wood-boring beetles lead the invasion.

Wildlife trees that are alive or in the early stages of decay attract birds that build large open nests, such as Ospreys, Bald Eagles and Great Blue Herons, or cavity excavators such as woodpeckers.

The presence of the following **defects on LIVE** trees can be used to distinguish Class 2 trees from Class 1 trees:

- Fungal conks and/or internal decay
- Tree cavities
- External stem scars
- Stem cracks/splits (such as frost cracks)
- Dead or broken tops (including secondary tops and forks)
- Large dead limbs (>10cm diameter) – note that natural self-pruning is not a defect
- Damaged roots (from disease, fire or mechanical damage)
- Excessive lean (>30%) **AND** damaged/diseased roots or a poor anchoring soil substrate – note that "sweep" is not a lean defect
- Large canker face
- Unusual stem swellings (may indicate hidden decay)
- Insect or fire damage such that tree is likely to die relatively soon (i.e., become a Class 3 tree)



*Class 2: showing large hung-up dead limb*

**Class 3, 4, and class 5 conifers:** The tree has died, and decay begins or continues. Class 3 trees are RECENTLY dead, still bearing their fine branches and twigs, and the bark is “tight”. Class 4 trees have lost their fine twigs and only have larger, coarse limbs left, and bark has begun to loosen or shed on parts of the stem. Class 5 trees have usually lost all their limbs but have not yet broken their tops, and the bark will be missing on parts of the stem. Woodpeckers will chisel out nesting cavities, taking advantage of the outer shell of sapwood that protects eggs and nestlings. As time passes, the tree continues to rot and soften. Bark is generally firm in Class 3 trees.

**Class 5 broad-leaved deciduous:** This is the tree class for deciduous trees before they fall to the ground as coarse woody debris. By this stage, the sapwood and heartwood are soft, portions of the bole have broken away, and most of the limbs are gone. Class 5 for deciduous trees is roughly equivalent to classes 6–7 for coniferous trees.

### Classes 6 and 7

When the tree reaches these stages, weaker excavators, such as nuthatches and chickadees, can make their nest holes in the soft wood. Branches are often broken off, and slabs of bark loosen from the trunk. Decay is advanced in the upper portions of the trunk. The loss of tree limbs creates knot holes and natural cavities, many of which are soon converted into homes by a variety of animals. Over the years, the tree becomes shorter as portions of the top snap off at weak points. Throughout stages 6 and 7, chunks of bark and sapwood are sloughed off and the upper bole of the tree has broken away. Generally up to 1/2 of the original top height of the tree has broken away. Once the softer heartwood is exposed, wildlife trees are used less by woodpeckers and more by other animal species. Class 6 for deciduous trees represents a dead fallen tree.

### Classes 8, 9

In the final phases of tree decay, all the sapwood is gone and the heartwood is completely rotted through. By class 8, only about 1/3 or less of the original tree height remains—the heartwood is highly decayed and is often visible as brown-cubical sloughing fragments. At class 9, the stump and the mound of woody debris that surrounds it become an ideal site for new plant growth, providing a ready supply of moisture and nutrients. It has now become suitable habitat for amphibians, such as the clouded salamander, that require moist, thermally buffered environments.





*Class 4: dead tree, with only larger coarse limbs remaining*

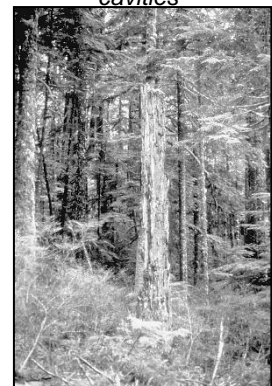

*Class 7: soft heartwood, showing numerous nest cavities*

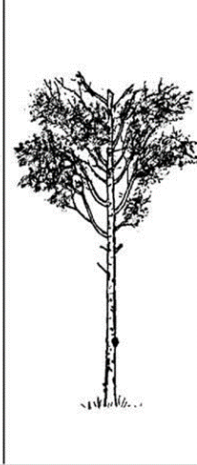
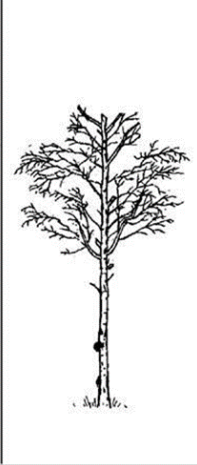
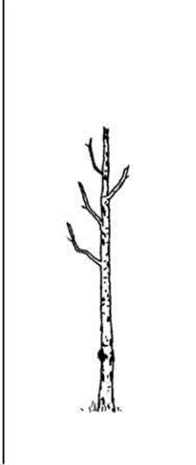
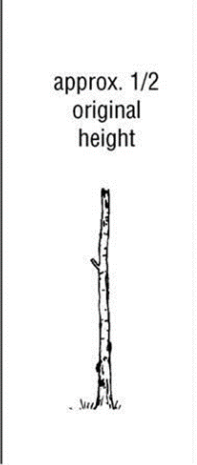

*Class 8*

Tree class	LIVE		DEAD			DEAD FALLEN
	1	2	hard 3	spongy 4	soft 5	6
						

British Columbia's wildlife tree classification system (native broad-leaved deciduous)

**NOTES:**

Class 1 and 2 trees are LIVING trees. A class 1 tree is healthy, but a class 2 tree is unhealthy (it may be damaged, dying, diseased, injured). A broken top or a dead top are NOT a pre-requisite to being labelled as a Class 2 tree (these are simply two image examples of 'unhealthy' trees).

---



---



---



---



---

British Columbia's wildlife tree classification system (conifers)

Tree Class	LIVE			DEAD			DEAD FALLEN		
	1	2	3	4	5	6	7	8	9
	Hard			Spongy			Soft		
<b>Description</b>	<b>Live/healthy;</b> no decay; tree has valuable habitat characteristics such as large, clustered or gnarled branches, or horizontal, thickly moss-covered branches.*	<b>Live/unhealthy;</b> internal decay or growth deformities (including insect damage, broken tops); dying tree.*	<b>Recently dead;</b> needles or fine twigs are present; bark is tight.	<b>Dead;</b> no needles or fine twigs—only coarse limbs present; 50% of branches lost; loose bark.	<b>Dead;</b> most branches absent; some internal decay; sapwood decay present; bark shedding; weak top.	<b>Dead;</b> no branches or bark; sapwood/heartwood sloughing from upper bole; decay more advanced.	<b>Dead;</b> extensive internal decay; outer shell may be hard; lateral roots usually completely decomposed; hollow or nearly hollow shells.	<b>Dead;</b> extensive internal decay; outer shell may be hard; lateral roots usually completely decomposed; hollow or nearly hollow shells.	<b>Debris;</b> downed trees or stumps.
<b>Uses and users</b>	Nesting (e.g., Bald Eagle, Great Blue Heron colonies, Marbled Murrelet); feeding; roosting; perching.	Nesting/roosting <sup>1</sup> —strong PCEs <sup>2</sup> (woodpeckers); SCU <sup>3</sup> ; large-limb and platform nests (Osprey); insect feeders.	Nesting/roosting—strong PCEs; SCU <sup>3</sup> ; bats.	Nesting/roosting—PCEs; SCU <sup>3</sup> ; insect feeders.	Nesting/roosting—weak PCEs (nuthatches, chickadees); SCU <sup>3</sup> ; bats; insect feeders.	Weaker PCEs; SCU <sup>3</sup> ; insect feeders; salamanders; small mammals; hunting mammals.	Insect feeders; salamanders; small mammals; hunting mammals; occasionally used by weak cavity excavators such as chickadees.	Insect feeders; salamanders; small mammals; hunting mammals; occasionally used by weak cavity excavators such as chickadees.	Insect feeders; salamanders; small mammals; hunting mammals; occasionally used by weak cavity excavators such as chickadees.

1 Large 'witches' brooms provide nesting/denning habitat for some species (e.g., fisher, squirrels).  
 2 PCE = primary cavity excavator.  
 3 SCU = secondary cavity user.  
 4 \* This classification system does not recognize root disease trees specifically. Such trees become unstable at or before death.

## THE IMPORTANCE OF WILDLIFE TREES

Wildlife trees at all stages provide a portion of the life support system for many species of plants, invertebrates, birds, amphibians, reptiles and mammals. Altogether, more than 80 animal species in British Columbia depend on dead or deteriorating trees. Some of their uses include nesting, feeding, communication (drumming, marking), roosting, shelter and over-wintering.

Some highlights include:

- The largest group of wildlife tree users are cavity-nesting birds, such as owls, woodpeckers, and some ducks.
  - ~ There are about 19 species of primary cavity-nesting birds in British Columbia.
  - ~ There are about 31 species of secondary cavity-nesting birds in British Columbia.
  - ~ Approximately 18% of the bird species known to breed in British Columbia are cavity nesters.
- More than 30 species of mammals in British Columbia use wildlife trees.
  - ~ Marten and Fisher often raise their young in tree cavities.
  - ~ Black bears often hibernate in hollow trees.
  - ~ Several kinds of bats roost in tree cavities or behind the loose bark of dead trees.
- Birds of prey, including Bald Eagles, Ospreys and some hawks, use the branches of these trees as perches, and often build their nests in dead or broken-topped trees.
- Woodpeckers, nuthatches and Brown Creepers forage on bark for a variety of insect pests.
- The long list of wildlife tree users includes some rare and endangered birds and mammals.
- In all, there are more than 80 wildlife tree-dependent species in British Columbia.

Wildlife tree users can be divided into five general groups:

1. primary cavity excavators;
2. secondary cavity users;
3. open nesters;
4. mammals; and
5. amphibians.

Note: A complete list of wildlife tree-dependent terrestrial invertebrates and their dependency levels can be found in Appendix 2.

UBC manages a Big Tree Registry. The aim is to identify, describe, monitor, and conserve the largest trees of each species within British Columbia, and to educate and enlist the help of its citizens in this task. Note that a Big Tree is not necessarily a Special Tree as defined by the Special Tree Protection Regulation.

### Primary Cavity Excavators

- Primary cavity excavators are adapted to chisel out holes in the decaying wood of trees. They usually make new nest holes each year, leaving the old ones to be used by other wildlife. Woodpeckers and sapsuckers are primary cavity excavators, as are some species of chickadees and nuthatches.
- Primary cavity excavators depend on the availability of dead or defective trees for nesting sites, and often for roosting and foraging sites as well. Cavity excavation and drumming are a part of their communication system, and also play a role in mating. Many of B.C.'s woodpeckers are year-round residents, so trees in which they can excavate thick-walled roosting cavities are an essential part of their winter roosting habitat. B.C.'s four species of chickadees and three species of nuthatches are also year-round residents that use cavities for both nesting sites and winter roosts. Pygmy Nuthatches often roost communally in winter for heat conservation, with up to 150 birds sharing a single roost.



*Hairy Woodpecker – a primary cavity excavator.*

### Secondary Cavity Users

- Secondary cavity users are birds and mammals that cannot excavate their own holes. They raise their young in abandoned holes of primary cavity nesters and in natural cavities created by decay, loose bark, lost branches and lightning strikes. This group may also use wildlife trees for food storage and temporary shelter. They include small owls, swallows, bluebirds, some ducks, marten, fisher, raccoons, flying squirrels, deer mice and bats.

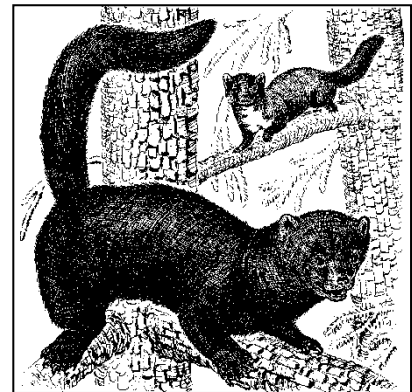

*Fisher, which are secondary cavity users, often use wildlife trees to raise their young and for year-round shelter.*

For a guide to identifying Fisher Habitat structures, refer to the following pictorial guide:

[https://www.bcfisherhabitat.ca/wp-content/uploads/2021/07/2021\\_Pictorial-Guide-of-Important-Fisher-Habitat-Structures-in-British-Columbia.pdf](https://www.bcfisherhabitat.ca/wp-content/uploads/2021/07/2021_Pictorial-Guide-of-Important-Fisher-Habitat-Structures-in-British-Columbia.pdf)

## Open Nesters

- Cavity-nesting birds are not the only birds that require wildlife trees. Birds that build large, heavy nests in the tops of big trees are called open nesters. Great Blue Herons, Bald Eagles, Ospreys, and the largest hawks and owls depend on large trees that can support their bulky, heavy nests. They do not necessarily require dead or decaying trees, but broken-top, split-top, or flat-crown trees are favoured because of their open, flat structure. Some open nesters depend on wildlife trees for hunting perches. Several open nesters are named as protected species under Section 34 of the *Wildlife Act*.

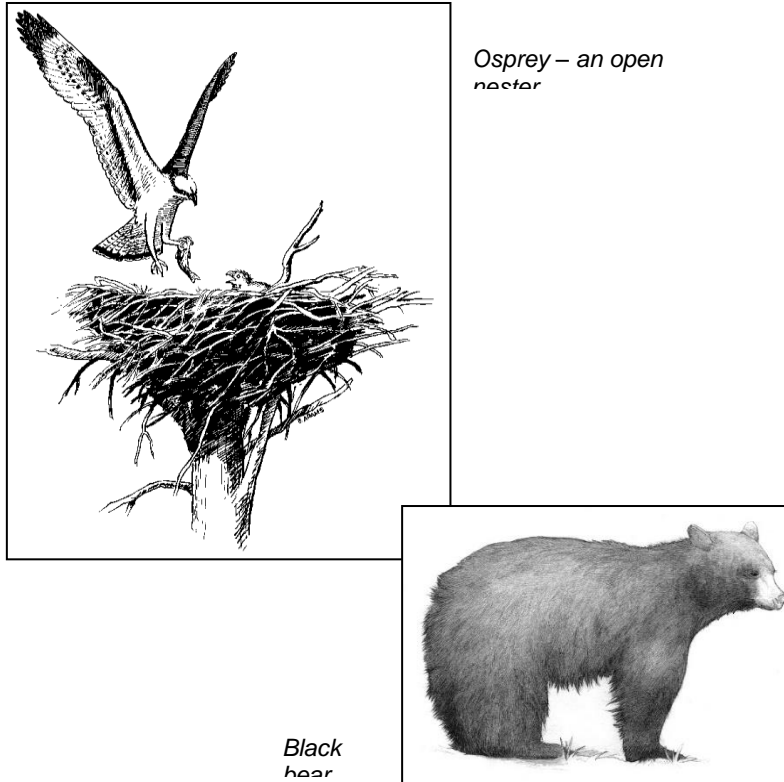

*Osprey – an open nester*

*Black bear*

## Mammals

- Black bears are known to hibernate in hollow trees with entrance openings <50cm. The mountain caribou's main winter food is arboreal lichens, which grow on the branches of old and/or dead trees. Marten and fisher den in tree cavities and hollow logs. Bats roost and nurse their young behind loose bark or inside dead, hollow trees. Of all mammals, bats are perhaps the most dependent on wildlife trees.

**NOTE:** Tree damage and internal decay resulting from prominent stem wounds such as frost cracks and “catface” scars (particularly on balsam poplar, lodgepole pine, trembling aspen and cottonwood), and which have a relatively narrow external opening/entrance, can be used as den sites for furbearers such as marten and fisher. These species require **specific cavity entrance dimensions** in the range of 5-12 cm wide.

## Amphibians

- Amphibians, including the wandering, clouded and western red-backed salamanders, use the soft, moist wood found in highly decayed wildlife trees and fallen logs as shelter, and for laying their eggs.

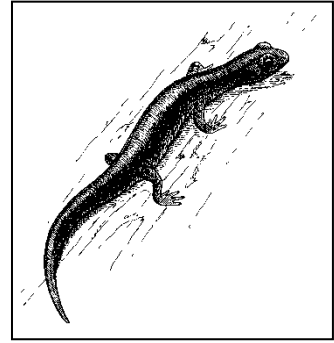

*Western red-backed salamander.*

## Wildlife Act

In British Columbia, only Section 34 of the *Wildlife Act* concerns wildlife trees, albeit indirectly. It reads as follows:

**“A person who, except as provided by regulation, possesses, takes, injures, molests or destroys**

**(a) a bird or its egg,**

**(b) the nest of an eagle, peregrine falcon, gyrfalcon, osprey, heron or burrowing owl, or**

**(c) the nest of a bird not referred to in paragraph (b) when the nest is occupied by a bird or its egg**

**commits an offence.”**

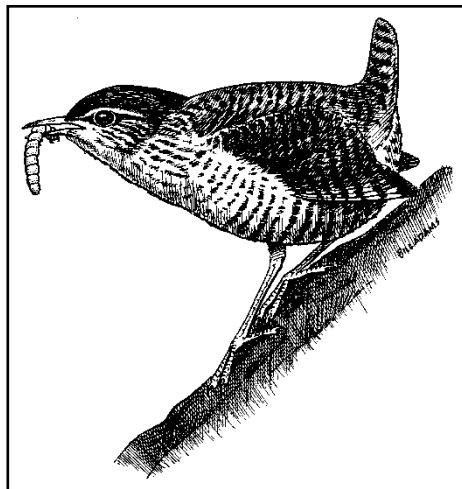

*Winter Wren feeding on insect pest.*

**Refer to Appendix 3 for additional pertinent regulations concerning wildlife tree management.**



## Wildlife Tree Users Under Pressure

Wildlife tree users include more than two dozen species considered to be either threatened or endangered. Appendix 2 shows the uses and level of ecological dependency of indigenous wildlife tree users in B.C.

Status designations below are from the B.C. Ministry of Environment and Climate Change Strategy's Red, and Blue Lists (2017). Red-Listed species are those being considered for legal designation as Endangered or Threatened under the *B.C. Wildlife Act*. Blue-Listed species are considered vulnerable and/or sensitive and at risk because of low or possibly declining populations. Species may also be placed on the Blue List because of inadequate understanding of their status.

Some of the species below have also been listed as federally Endangered or Threatened by COSEWIC (Committee on the Status of Endangered Wildlife in Canada). For further information on federal listings, refer to [http://www.sararegistry.gc.ca/species/default\\_e.cfm](http://www.sararegistry.gc.ca/species/default_e.cfm) for the *Species at Risk Act Public Registry*.

### RED-Listed Wildlife Tree Users: Endangered/Threatened Species

Northern Goshawk (coastal *laingi* subspecies)  
Spotted Owl  
Barn Owl  
Western Screech-Owl (*macfarlanei* subspecies)  
Lewis's woodpecker (Georgia Depression)  
Western bluebird (Georgia Depression)  
White-headed Woodpecker  
Swainson's hawk  
Pallid Bat  
Red-tailed Chipmunk (*ruficaudus* subspecies)  
Least Chipmunk (*selkirki* subspecies)  
Ermine (*haidarum* subspecies)  
Long-tailed Weasel (*altifrontalis* subspecies)  
Mountain Caribou (southern & boreal populations)

**Note:**

The subspecies listed on this page have limited ranges in specific regions of the province.

**BLUE-Listed Wildlife Tree Users: Vulnerable/Sensitive Species**

- Great Blue Heron
- Williamson's Sapsucker (*nataliae* subspecies)
- Flammulated Owl
- Marbled Murrelet
- Northern Pygmy-Owl (*swarthi* subspecies)
- Northern Saw-Whet Owl (H.Gwaii *brooksi* subspecies)
- Western Screech-Owl (*kennicottii* subspecies)
- Lewis's Woodpecker
- Williamson's Sapsucker
- Hairy Woodpecker (H.Gwaii *picoideus* subspecies)
- Purple martin
- Olive-sided Flycatcher
- Fringed Myotis (bat)
- Keen's Long-eared Myotis (bat)
- Northern Long-eared Myotis (bat)
- Western Small-footed Myotis (bat)
- Spotted Bat
- Townsend's Big-eared Bat
- Least Chipmunk (*oreocetes* subspecies)
- Red-tailed Chipmunk (*simulans* subspecies)
- Ermine (*anguinae* subspecies)
- Fisher
- Mountain caribou (Northern Mountain population)
- Black Bear (*emmonsii* subspecies)

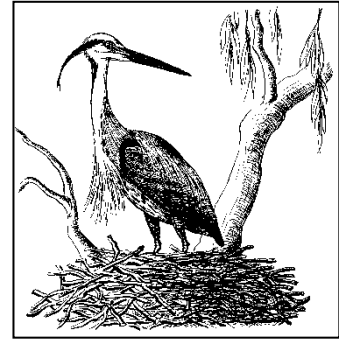

Great Blue Heron nesting in a suitable wildlife tree.

**For further information on Red- or Blue-listed wildlife in British Columbia, contact the B.C. Conservation Data Centre in Victoria (<http://www2.gov.bc.ca/gov/content/environment/plants-animals-ecosystems/conservation-data-centre>)**

**NOTES:**

---

---

---

---

## THE ECOLOGICAL AND ECONOMIC SIGNIFICANCE OF WILDLIFE TREE USERS

Wildlife tree-dependent species have a number of ecological roles in B.C. forests. Some of these roles are perceived as extremely valuable, others have traditionally been viewed as negative from an economic perspective, and many require further investigation.

One of the most important and well-documented roles of wildlife tree users is their impact on forest pest populations. Each year, B.C. forests are subject to damage from a variety of pest species. These pests kill trees and reduce tree growth and vigor, thereby reducing the economic potential of our forests. Bark beetles, spruce budworm and Douglas-fir tussock moth are examples of some of the most damaging insect pests in B.C. Between 1998 and 2009, Mountain Pine Beetle killed an estimated 675 million cubic metres in B.C., equal to about 50% of the Province's commercial pine. Although the relative impact of vertebrate pests on our forests is considered small, some species (e.g., voles, squirrels, rabbits, snowshoe hares and porcupines) can cause significant economic losses under certain conditions.

To identify which wildlife tree-dependent species are important predators of forest pests, wildlife tree users can be grouped into "feeding guilds" (Tables 2 and 3) for birds and mammals, respectively. Birds of prey and carnivores feed on a variety of small mammals, some of which eat conifer seeds or damage seedlings and saplings. Bark-foraging birds, foliage-gleaning birds, and aerial-foraging birds feed largely on insects. Differences in bill structure and feeding location result in the partitioning of insect prey types (e.g., defoliators, sucking insects, woody tissue feeders) and life stages (e.g., larvae, pupae, adults) among group members. All 13 wildlife tree-dependent bats are insectivorous, but little is known about their consumption of specific pest insects.



*Spruce budworms.*



Woodpecker bark scaling for mountain pine beetle larvae.

Avian wildlife tree user feeding guilds that consume forest pests (adapted from Machmer and Steeger 1995)

Wildlife Tree User Guild	Guild Members	Predator Example	Prey Example	General Remarks
Birds of prey	eagles <sup>1</sup> , hawks <sup>2</sup> , falcons <sup>3</sup> , owls <sup>4</sup>	Golden Eagle	rabbits, hares, rodents	<ul style="list-style-type: none"> <li>rodents, pikas, rabbits and hares are the most common food item of 13 of the 17 species in this group</li> </ul>
Bark-foraging birds	sapsuckers <sup>5</sup> , woodpeckers <sup>6</sup> , Northern Flicker, nuthatches <sup>7</sup> , Brown Creeper	White-headed Woodpecker	bark beetles (e.g., mountain pine beetle)	<ul style="list-style-type: none"> <li>forest insects make up <math>\geq 75\%</math> of the diet volume in 11 of the 15 species in this group</li> <li>13 of the 15 species are known to eat a variety of <i>pest</i> insects</li> </ul>
Foliage-gleaning birds	chickadees <sup>8</sup>	Black-capped Chickadee	moths, budworms, loopers, beetles, weevils	<ul style="list-style-type: none"> <li>forest insects are the most common food item of the 4 species in this group</li> <li>all 4 species are known to eat a variety of <i>pest</i> insects</li> </ul>
Aerial-foraging birds	flycatchers <sup>9</sup> , swallows <sup>10</sup> , bluebirds <sup>11</sup> , Flammulated Owl, Lewis' Woodpecker, Vaux's Swift, Purple Martin	Violet-green Swallow	beetles (e.g., western pine beetle)	<ul style="list-style-type: none"> <li>insects make up <math>\geq 75\%</math> of the diet volume in 9 of the 10 species in this group</li> <li>5 of the 10 species are known to prey on <i>pest</i> insects</li> </ul>

<sup>1</sup> eagles = Bald Eagle, Golden Eagle

<sup>2</sup> hawks = Northern Goshawk, Red-tailed Hawk, Swainson's Hawk, Cooper's Hawk

<sup>3</sup> falcons = American Kestrel, Merlin

<sup>4</sup> owls = Barn Owl, Western Screech-Owl, Great Horned Owl, Northern Hawk Owl, Northern Pygmy-Owl, Spotted Owl, Barred Owl, Boreal Owl, Northern Saw-whet Owl

<sup>5</sup> sapsuckers = Yellow-bellied Sapsucker, Red-naped Sapsucker, Red-breasted Sapsucker, Williamson's Sapsucker

<sup>6</sup> woodpeckers = Downy Woodpecker, Hairy Woodpecker, White-headed Woodpecker, Three-toed Woodpecker, Black-backed Woodpecker, Pileated Woodpecker

<sup>7</sup> nuthatches = Red-breasted Nuthatch, White-breasted Nuthatch, Pygmy Nuthatch

<sup>8</sup> chickadees = Black-capped Chickadee, Mountain Chickadee, Boreal Chickadee, Chestnut-backed Chickadee

<sup>9</sup> flycatchers = Pacific-slope Flycatcher, Ash-throated Flycatcher

<sup>10</sup> swallows = Tree Swallow, Violet-green Swallow

<sup>11</sup> bluebirds = Western Bluebird, Mountain Bluebird

Mammalian wildlife tree user guilds that consume forest pests (adapted from Machmer and Steeger 1995)

Wildlife Tree User Guild	Guild Members	Predator Example	Prey Example	General Remarks
Aerial-foraging bats	Myotis spp. <sup>1</sup> , Big Brown Bat, Silver-haired Bat, Pallid Bat, Hoary Bat	Big Brown Bat	beetles, moths	<ul style="list-style-type: none"> <li>all 13 species in this group are insectivorous</li> <li>investigations of specific pest species consumed are under way</li> </ul>
Terrestrial and arboreal rodents	mice <sup>2</sup> , squirrels <sup>3</sup> , chipmunks <sup>4</sup> , Southern Red-backed Vole, Bushy-tailed Wood Rat	Red Squirrel	moths (e.g., spruce budworm)	<ul style="list-style-type: none"> <li>insects comprise part of the diet of at least 6 of 12 species in this group; 4 species are known to consume <i>pest</i> insects</li> <li>fungi is the predominant food for several species</li> </ul>
Carnivores	Weasels <sup>5</sup> , Marten, Fisher, Ermine, Spotted Skunk, Black Bear, Raccoon	Marten	rodents, rabbits, hares	<ul style="list-style-type: none"> <li>small to medium-sized mammals (many of which are considered pests) are the first-ranked foods for 5 of 8 species in this group</li> </ul>

<sup>1</sup> Myotis spp. = California Myotis, Western Small-footed Myotis, Western Long-eared Myotis, Keen's Long-eared Myotis, Little Brown Myotis, Northern Long-eared Myotis, Long-legged Myotis, Yuma Myotis

<sup>2</sup> mice = Deer Mouse, Columbia Mouse, Sitka Mouse

<sup>3</sup> squirrels = Flying Squirrel, Douglas Squirrel, Red Squirrel

<sup>4</sup> chipmunks = Yellow-pine Chipmunk, Least Chipmunk, Red-tailed Chipmunk, Townsend's Chipmunk

<sup>5</sup> weasels = Long-tailed Weasel, Least Weasel

Wildlife tree users eat forest pest species and therefore reduce the damage incurred by these pests. However, this does not tell us whether wildlife tree users can in fact control the abundance of certain pests. Some of the best evidence for this type of control comes from the bark-foraging guild.

Three-toed, Black-backed, and Hairy Woodpeckers eat mainly insects, and in winter they specialize on wood-boring beetle larvae. They use their chisel-shaped bills to drill beneath the bark and then extract the larvae with their unique tongues (Figure 3). Three-toed Woodpeckers show impressive rates of consumption using this feeding technique. During a spruce beetle outbreak, their stomachs contained an average of 915 beetles per bird, with each bird filling its stomach to capacity several times a day. Many studies show that woodpeckers can impact beetle populations; they respond *directly* to beetle outbreaks by including more beetles in their diet and by aggregating in outbreak areas, especially in winter.

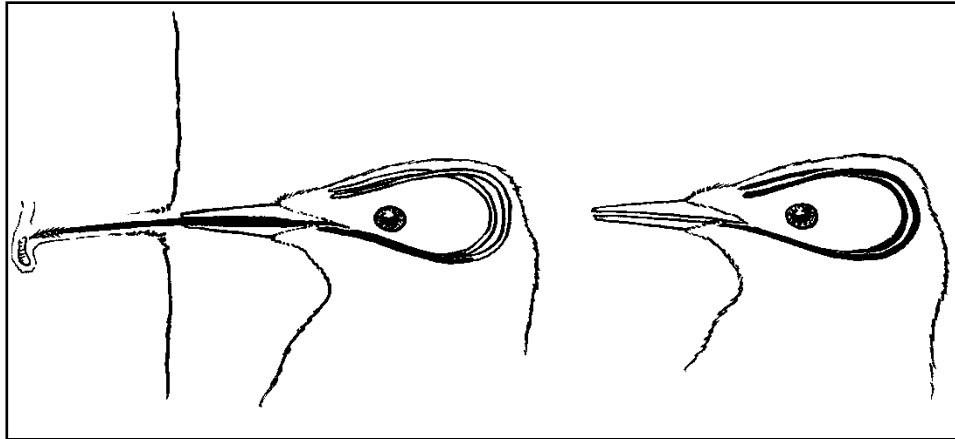

Most woodpeckers have very long tongues that wrap around the skull when retracted (right). When extended (left), they can probe deep into holes drilled into trees. The tip of the tongue is barbed and coated with sticky saliva to help extract prey.

Figure 3. Specialization of woodpecker tongues (adapted from Ehrlich et al. 1988).

Woodpeckers also increase beetle mortality *indirectly* through their feeding activities. The process of excavating beneath the bark alters the microhabitat of the beetle larvae, making them more susceptible to temperature extremes, desiccation, and attack by parasitic or predaceous insects. Other predators (e.g., Brown Creeper, Red-breasted Nuthatch) are also drawn to “woodpeckered” bark where they can access beetle larvae. Both the direct and indirect effects of woodpecker feeding activity contribute to the biological control of bark- and wood-boring beetles.

In general, cavity-nesting birds play an important role in maintaining insect pests at low levels by delaying the onset of an insect outbreak and accelerating its decline. Their main benefit lies in preventing outbreaks rather than in controlling established outbreaks. The feeding habits of aerial-foraging bats suggest that they too could play a significant role in controlling insect pests. Maintaining healthy populations of all of these predators makes good biological and economic sense.

Wildlife tree-dependent rodents are usually considered as pests that impede reforestation. This perception is changing as we learn more about the role these species play in a complex cycle integral to the health of our forests (Figure 4). In the process of feeding, forest rodents disperse spores of mycorrhizae (“fungus-root”), which are associations between fungi and the roots of plants. Virtually all commercially-valuable trees in B.C. (e.g., pine, fir, spruce, larch, hemlock) depend on these root-inhabiting fungi to absorb adequate nutrients for growth.

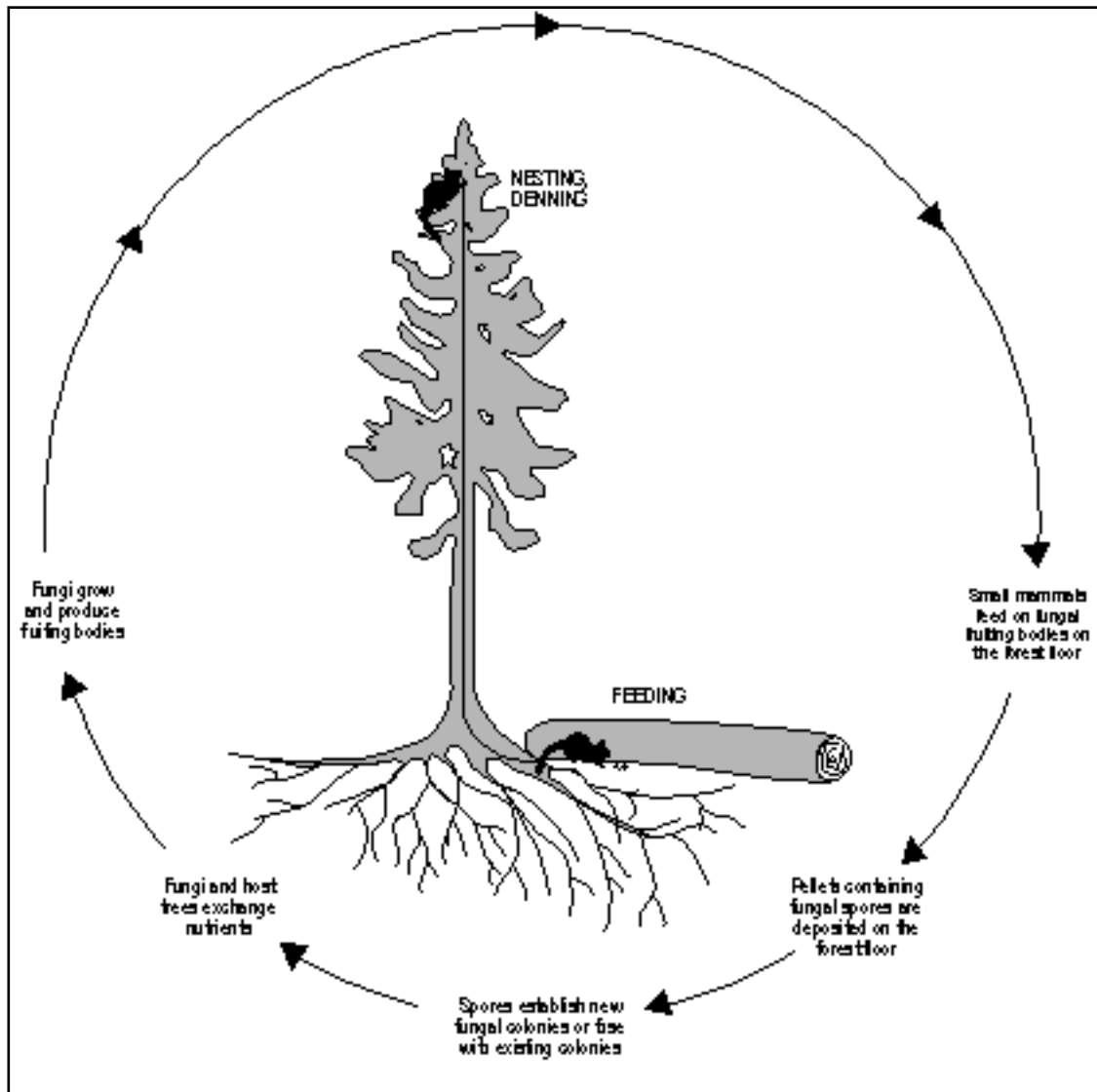

Figure 4. Root-fungus–small mammal interrelationships (adapted from C. Maser 1988).

Some wildlife tree-dependent rodents (e.g., flying squirrel, southern red-backed vole) rely on fungi for food, especially in winter. In turn, those mycorrhizae fungi that produce their fruiting bodies underground rely on small mammals for spore dispersal. Small mammals smell and dig up nutritious fungal fruiting bodies. Once eaten, fungal spores pass through the rodent digestive tract and are excreted into pellets. Spores within these pellets can establish a new fungal colony on a tree root system. By dispersing spores, small mammals act as a critical link in a cycle that promotes the growth and survival of our forests.





## **Section Two**

### **WILDLIFE/DANGEROUS TREE ASSESSMENT**

#### **Learning Objectives**

- Terms of Reference
- What is a Dangerous Tree?
- Level of Disturbance
- Site Assessment Overview
- Visual Tree Inspection
- Detailed Tree Assessment
- Overall Tree Danger Rating
- Safety Procedures
- Dangerous Trees Along Roadsides
- No-work Zones
- Marking and Documentation
- Assessing Trees in High Stem Density Sites



## TERMS OF REFERENCE

Forest activities are an inherently hazardous activity. Every effort must therefore be made to ensure that owners, supervisors and workers work together to identify and reduce exposure to work site hazards. The Worker's Compensation Act (sections 115 – 119) outlines the general duties of Owners, Employers, Supervisors, Workers and Prime Contractors (Multiple Employer Worksites) with regard to ensuring work site hazards are identified and controlled.

Dangerous trees are a common work site hazard in forestry operations and similar activities. In British Columbia, the Forest Operations module of the Wildlife/Dangerous Tree Assessor's Course (WDTAC) is recognized as the standard of care for identifying, assessing and controlling exposure to dangerous trees. Participants taking the WDTAC are instructed and trained how to identify and assess dangerous trees, and then how to implement safe work procedures BEFORE workers arrive at the work site.

Assessment of dangerous trees should be done as early as possible so that supervisors have time to eliminate or control the risks associated with dangerous trees. WCB Occupational Health and Safety (OHS) Regulations require that a risk assessment be performed as part of works site safety planning. OHS Regulation 26.2 "Planning and Conducting a Forestry Operation" emphasizes the need for anticipating what could happen BEFORE it happens, and then making a plan to eliminate or minimize the risks.

### **Points of Control Matrix (POC)**

The risk assessment process for managing wildlife and dangerous trees in forestry operations can best be summarized by developing a "points of control" (POC) matrix. The POC matrix is an effective framework for developing a safety management system. Appendix 3 shows a POC matrix for use in preparation for silviculture activities in high-density stem count areas.

The POC matrix guides setting clear objectives, coordinating hazard planning, communicating among workforce tiers, and establishing controls and feedback processes to ensure the safety of all workers. Therefore, the Wildlife/Dangerous Tree assessor performs an integral role in promoting habitat conservation and worker safety in forestry operations. The sections that follow demonstrate how to perform the duties of an assessor, and how to document and communicate safe work procedures for managing wildlife/dangerous trees during Forest Operations activities.

## WHAT IS A DANGEROUS TREE?

In the past, the term “snag” has been synonymous with “danger” and was historically defined in forestry operations as *a standing dead or dying tree over 3 metres in height*. However, not all snags are dangerous and live trees often have defects that are hazardous to workers. Consequently, the term “snag” has been replaced with “dangerous tree” in OHS Regulations part 26.1.

The following definition of “dangerous tree” now applies:

### **A DANGEROUS TREE...**

*... means a tree (live or dead, regardless of size) that is a hazard to a worker due to:*

- (a) its location or lean,*
- (b) its physical damage,*
- (c) overhead conditions,*
- (d) deterioration of its limbs, stem or root system, or*
- (e) any combination of the conditions in paragraphs (a) to (d).*

With reference to dangerous trees and the workplace, OHS Regulation 26.11 (1) (see also Appendix 4) states: *If it is known or reasonably foreseeable that work will **expose** a worker to a dangerous tree, (a) the tree must be removed or (b) a risk assessment of the tree must be undertaken.*

The procedures for determining whether a tree is dangerous to workers under various levels of disturbance, and the appropriate steps and safety procedures for avoiding the hazard, are described in the following sections.

## DETERMINING TREE DANGER RATING

There are **5 steps** required to determine tree danger rating:

1. **Determine the level of ground disturbance** (refer to Tables 1, 1A)
2. **Conduct a site assessment overview** (refer to Table 2)
3. **Conduct tree assessments** (refer to Tables 3, 4, 4A and 5)
4. **Make the appropriate safety decision** (Safe or Dangerous)
5. **Provide documentation and communicate safety procedures**

*This 5-step process is described in the sections that follow. Persons interested in dangerous tree assessment must understand that the processes described herein must be combined with field training and diligent practice.*

**Note: Suspect trees within reach of forestry operations must be diligently managed by applying the full WDTAC process, and that means ALL the steps.**

## STEP 1: Determine Level of Disturbance and Type of Activity

### Level of Disturbance (LOD)

Various work activities are associated with differing levels of disturbance (LOD). Activities rated as low disturbance create minimal ground or tree disturbance and as a result, expose workers to very little danger. However, as the level of disturbance increases so does the potential danger. As a result, fewer activities are appropriate around potentially dangerous trees under situations of high ground or tree disturbance (e.g., helicopter logging), or where exposure to people and facilities is of long or constant duration (e.g., office buildings).

Table 1 relates level of disturbance (1 – 4 = “low, medium, high, very high”) with various work activities. Table 1A describes wind speed disturbance equivalencies.

### Very low risk (VLR) activities (heads up, situationally aware workers)

Some activities result in **negligible levels of ground or tree disturbance and have low exposure time** to potential tree hazards. Consequently, the risk of injury due to tree hazards is very low. For the most part these are field reconnaissance activities that involve foot travel and survey or layout work, or travel on roads and trails with light vehicles (pickups, UTVs/ATVs) to work areas. Very low risk activities include:

- forest surveys
- stand reconnaissance
- tree marking
- worksite engineering and layout
- general light vehicle travel (pickups, UTVs/ATVs)
- foot travel & safety egress (walking, hiking, horseback riding).

For these situations, workers should keep a “heads-up” awareness of their surroundings and stay away from any obvious overhead tree hazards (e.g., insecurely lodged trees; hanging tops or limbs), and observe standard operating procedures for weather-related work shutdown (e.g., wind speed, fog, snow, rainfall).

For further details about significant tree hazards, see Table 3.

**NO pre-work site inspection is required for the very low risk activities listed above**

Table 1. Levels of disturbance for unprotected workers in various work activities

Level of Disturbance*	Example Types of Work Activities in Harvesting & Silviculture Activities	Example Types of Work Activities in Geophysical Projects
Very Low Risk** (No Pre-work DT Assessment)	<ul style="list-style-type: none"> <li>Forest surveys, stand recce, tree marking, road &amp; cutblock layout, foot travel</li> <li>General light vehicle travel (pickups, ATV/UTV)</li> </ul>	<ul style="list-style-type: none"> <li>Walking, surveying, safety egress (heads up work)</li> <li>General light vehicle travel (pickups, ATV/UTV, snow sleds)</li> </ul>
1 (Table 3) WIND: <40km/hour	<ul style="list-style-type: none"> <li>Tree planting</li> <li>Brushing &amp; Weeding, Firewood bucking</li> <li>Tree pruning (stems &lt;20 cm dbh)</li> <li>Use of light-duty machinery (e.g., weed whips, brush saws)</li> <li>Road travel with heavy vehicles (&gt;5500 kg GVWR) on a constructed and maintained resource road</li> <li>Fire control with hand tools and/or water hoses</li> </ul>	<ul style="list-style-type: none"> <li>Placing/retrieving recording lines (e.g., geophones)</li> <li>Power tool brushing/slashing</li> <li>Bucking logs (any size), or downed trees &lt;15cm dbh</li> <li>Seismic blasting &lt;4kg charges (properly placed)</li> <li>Seismic line rehabilitation (manual works, light duty machinery)</li> <li>Road travel with heavy vehicles (&gt;5500 kg GVWR) on constructed &amp; maintained resource roads</li> </ul>
2 (Table 4) WIND: <40km/hour	<ul style="list-style-type: none"> <li>Road travel with heavy vehicles (&gt;5500 kg GVWR) on a trail or overgrown road</li> <li>Maintenance or construction activities without heavy equipment (e.g., small machines such as "bobcats")</li> <li>Tree pruning (stems &gt;20 cm dbh)</li> <li>Juvenile spacing or slashing (stems &lt;15 cm dbh)</li> <li>Tree bucking (root plate attached)</li> </ul>	<ul style="list-style-type: none"> <li>Road travel with heavy vehicles (&gt;5500 kg GVWR; e.g., LIS Drills, Vibes) on seismic line or overgrown road</li> <li>Light duty equipment (e.g., LIS drills, small cats)</li> <li>Bucking downed trees &gt;15cm dbh (e.g., wind thrown trees with full root wad attachment)</li> <li>Seismic line construction (stems &lt;15cm dbh) with chainsaws***</li> <li>Seismic blasting &gt;4kg charges (properly placed)</li> <li>Road maintenance activities without excavations (e.g., brushing, ditch clearing)</li> </ul>
3*** (Table 4A) WIND: 40-65km/hour	<ul style="list-style-type: none"> <li>Tree falling (any tree &gt;15 cm dbh)****</li> <li>Cable yarding</li> <li>Ground skidding</li> <li>Mechanical harvesting and forwarding</li> <li>Helicopter logging with NO workers exposed to rotor wash</li> <li>Use of light and intermediate helicopters where workers are exposed to rotor wash (e.g., helipads)</li> <li>Mechanical site preparation, maintenance, and construction activities with heavy machinery</li> </ul>	<ul style="list-style-type: none"> <li>Tree falling (any tree &gt;15cm dbh)****</li> <li>Mechanical harvesting and ground skidding</li> <li>Use of light and intermediate helicopters where workers are exposed to rotor wash (e.g., slinging geophone bags)</li> <li>Land clearing &amp; site preparation/deactivation with heavy machinery</li> <li>Road maintenance or construction activities with heavy equipment</li> </ul>
4 (Table 5) WIND: >65km/hour	<ul style="list-style-type: none"> <li>Trees adjacent to corridors in partial-cut cable logging operations</li> <li>Harvesting operations in structurally damaged stands (e.g., wildfire burns)</li> <li>Surface rock blasting</li> <li>Helicopter logging with workers exposed to rotor wash</li> <li>Use of medium and heavy helicopters where workers are exposed to rotor wash</li> </ul>	<ul style="list-style-type: none"> <li>Use of medium and heavy lift helicopters where workers are exposed to rotor wash (e.g., slinging Heli seismic drill into position)</li> <li>Surface blasting (e.g., road construction)</li> </ul>

\*A dangerous tree assessment is only valid for the lowest level of disturbance at which the assessment has been done.

\*\*VLR activities are based upon the expectation that workers have been trained and mentored how to be situationally aware of the hazards expected in their workplace under a variety of forest and weather conditions.

\*\*\* If trees CANNOT be safely felled and yarded away from adjacent standing timber (i.e., there is a chance that felled or yarded timber will strike adjacent standing "leave timber"), then default to Level 4 disturbance.

\*\*\*\* Does not include dangerous tree falling and/or line slashing for fallen tree hazard mitigation. Falling of dangerous trees does not require reassessment to LOD3; the falling process must be in accordance with the BC Faller Training Standard and adherence to safe falling practices. Slashing and bucking to remove fallen hazards after mulcher line clearing does not require reassessment to LOD2.

Table 1A should be used to determine Level of Disturbance Windspeed Equivalency. This is most useful when there is a need to “bump-up” the LOD rating to a higher value in order to allow work to continue under increasing wind conditions. For example, where an assessment has been conducted for level of disturbance 1 or 2, constant winds or frequent gusts (as opposed to infrequent gusts) that exceed 40 km/h during the work activity render the initial assessment invalid. Table 1B is a useful guide to the types of helicopters and their lift capacity ratings.

**Therefore, in order to work under higher wind conditions, either stop work or reassess the potentially dangerous trees to an appropriate higher level of disturbance (e.g., LOD 3 = 40-65 km/h windspeed).**

In addition, trees can initially be assessed at a higher level of disturbance in order to compensate for expected higher winds during the period of work activity, or because the work activity itself may change (e.g., cable logging LOD 3 becomes heavy lift helicopter with chokerman LOD 4).

Table 1A. Influence of wind speed on level of disturbance

Wind Speed (km/h)	Description	Level of Disturbance Equivalency
0–40	<b>light breeze</b> (dust and loose paper raised; small branches move) to <b>fresh breeze</b> (small trees sway; tops of large trees sway)	1–2
40–65	<b>strong breeze</b> (small branches fly in the air; whole tree in motion; resistance felt when walking against wind)	3
65+	<b>gale</b> (branches broken off trees; walking impeded)	4

Table 1B. Helicopter types

Helicopter Category	Passenger Capacity	Lift Capacity
Type 1 (Heavy)	15+	Exceeds 2720kg (6000 lbs)
Type 2 (Medium)	9 – 14	1135 – 2720kg (2500-6000 lbs)
Type 3 (intermediate)	5 - 8	680 – 1134kg (1500 – 2500 lbs)
Type 4 (Light)	1 - 4	Not exceeding 680kg (1500 lbs)

The following listing provides examples of common aircraft by helicopter type and is a useful guide when determining the appropriate level of disturbance for the type of aircraft being used with ground crews exposed to rotor downdrafts (rotor wash).

**Light Category:** Jet Ranger (Bell 206), Hughes 500, Hiller 12, EC 120, R22 & R44

**Intermediate Category:** Long Ranger, A-Star (AS350), Bell 407, EC 130

**Medium Category:** K-Max, Bell 204, 212, 205

**Heavy Category:** Bell 214, Kamov, Sikorsky 61 & 64, BV 107 & 234

## STEP 2: Conduct Site Assessment Overview

Prior to going out to the field, review all available information relevant to the site (e.g., recent air photos, forest cover and terrain maps, silviculture prescriptions, site development plans, and stand management prescriptions, etc.). Review the management objectives for the site.

**How to use this table:** The following site/stand factors should be reviewed during a walkthrough of the site, prior to individual tree inspection. The site overview provides a context for what constitutes a suspect tree that requires inspection (i.e. it will identify overall site and tree risk factors which may lead to tree failures). **Information and site/stand factors found in the site overview can provide useful clues as to the condition and potential danger of individual trees.** Consider using the sample field card in Appendix 6 for documenting the planning and risk assessment process in accordance with OHS Regulation 26.2.

Table 2. Site Assessment Overview (for all tree species)

Site/Stand Factors	Hazard Indicators/Influences
Stand history and condition	<ul style="list-style-type: none"> <li>evidence of past tree failure</li> <li>disturbance history (natural or human-caused, including wildfire damage; age, condition and location of mechanically harvested "stubs")</li> <li>general age, condition and density</li> <li>tree species composition</li> <li>evidence of root and/or stem diseases</li> </ul>
Common rain, snow and ice conditions	<ul style="list-style-type: none"> <li>high snow or ice loading</li> <li>high rain fall periods</li> </ul>
Flooding	<ul style="list-style-type: none"> <li>high water table</li> <li>evidence of water damaged/decayed roots</li> <li>area prone to flooding</li> </ul>
Windthrow potential	<ul style="list-style-type: none"> <li>topography</li> <li>prevailing winds</li> <li>evidence of significant windthrow</li> <li>area of high or recent exposure</li> <li>stems with height/diameter ratio &gt;100 or small live crown (&lt;20% tree height) (i.e., very tall, slender stems)</li> <li>saturated soils</li> <li>shallow soils</li> <li>restricted rooting depth</li> <li>fine textured soils</li> </ul>
Crown condition (i.e., common root disease indicators)	<ul style="list-style-type: none"> <li>stress cone crop</li> <li>thinning foliage and/or chlorosis</li> <li>rounded crown</li> </ul>
Resinosis	<ul style="list-style-type: none"> <li>higher than normal stem or basal pitch flow (e.g., from butt rot, mechanical damage, root disease)</li> </ul>
Tree lean	<ul style="list-style-type: none"> <li>trees recently leaning due to windstorm, root damage, shifting root mat or other causes</li> </ul>
Additional site-specific factors	<ul style="list-style-type: none"> <li>based on local knowledge (e.g., soil or slope instability)</li> </ul>



Wildlife Dangerous Tree (WDT) Assessors must identify the critical site factors that will guide individual tree assessment. Information and observations made during the site assessment overview should be documented, especially when using this information to modify safety procedures or to assign a LOD to different treatment units (strata) at the worksite. For example, a plan to clear brush on a receiver line using brush saws during a seismic operation (LOD1) might actually need to be considered similar to slashing (LOD2) if the vegetation being treated is tall and dense, preventing clear and unobstructed views of a worker's surroundings or there is a need to slash and widen the line for safety egress.

WDT Assessors must also perform a risk assessment in relation to the season of work and consider the relationship of critical site factors. If treatments will be performed during a time where otherwise healthy, defect-free trees are prone to wind-induced failure (i.e., when shallow soils are wet) then consideration must be given to restricting work during high risk weather patterns (e.g., saturated soils and strong winds) or by creating wind speed shutdown criteria for the high-risk strata. If a higher level of care is required, then assessors must develop a safety plan that will provide control of the work site hazards – both known and foreseeable.

Therefore, steps 1 and 2 are a planning process that ensures assessors have considered all known or foreseeable worksite hazards prior to evaluating individual trees. This process will be used in step 5 to create a site safety plan that will control exposure to these hazards.

### **Assessing Work Site Perimeters**

As part of the Site Assessment Overview process, the WDT assessor must also determine where treatments will occur. The assessor needs to determine whether trees outside of work site perimeters are posing a risk (exposure) to the workers within the work site. If workers stop performing tasks at the work site boundary and all workers are directed to use a 'work away' from the boundary process, then there is a diminishing risk from disturbance to trees the farther one looks beyond the perimeter of the standing forest. However, workers can still be exposed to trees beyond the immediate perimeter which can fail and land into the work site.

Work site perimeters must be assessed for hazards, and the assessment process documented and communicated to subsequent workers. Suspect trees immediately along the boundary should be assessed to the corresponding LOD of the activities within the work site. Moving into the forest and away from the work site perimeter, assessors must continue to look for trees that could collapse and fall into the work site. However, the criteria used to assess suspect trees away from the perimeter are those used for LOD1, namely, looking for trees which are at imminent risk of failure.

Within the active work site, all suspect trees must be regarded as dangerous until proven safe if they are to be retained. If resource trees (e.g., culturally significant trees, rare and

endangered trees, high value wildlife habitat trees) are required to be retained within or alongside a work site, then the tree must be assessed for hazards according to the LOD of the work site activity, and workers instructed not to disturb these trees.

WDT Assessors must stratify their work site into two assessment zones (figure 5), the treatment zone (the active work site) and the perimeter zone (the area surrounding the treatment area). WDT Assessors need to make their assessment of both the treatment zone and the perimeter zone, and then communicate the safe work procedures to ensure trees are not disturbed during worker activities.

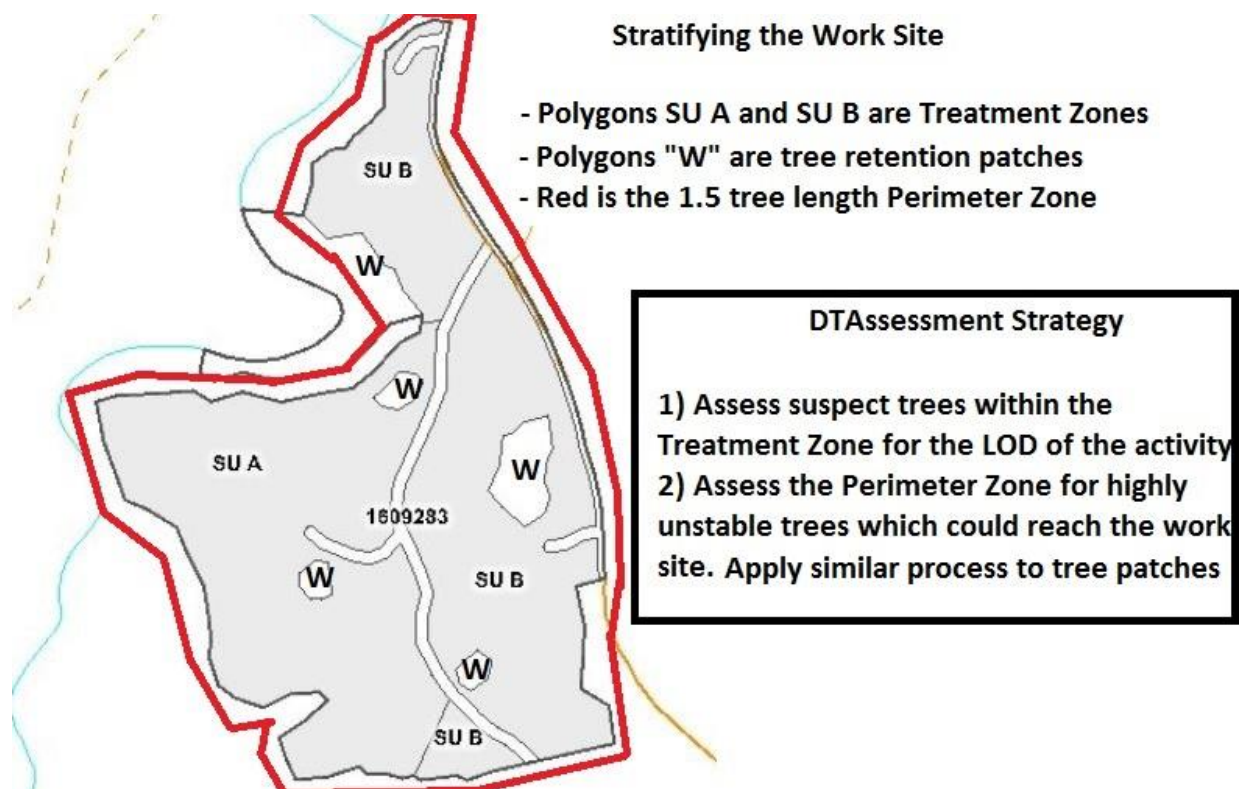

Figure 5: Example of a worksite stratified into tree assessment zones

The **Treatment Zone** consists of the active work site and the first 5 meters of the treatment area's boundary. The assessor will assess suspect trees located within the active work site and within 5m of the work site perimeter according to the dangerous tree criteria for the LOD of the activity being undertaken.

**NOTE:** The treatment zone for cable logging blocks must be extended out to all guy-line anchors, tail-hold anchors, back spar trees and tieback stumps/trees. Because of the forces/vibration exerted on those anchors, stumps and trees, they should be considered as LOD-3 for cable yarding. This would then cover hook-tenders or other rigging crew who may be working near active anchors (e.g., prepping the next road change, etc).

The **Perimeter Zone** consists of the 1.5 tree lengths of area surrounding the active treatment zone.

The experienced and certified WDT assessor must apply their knowledge, skills and experience when determining how to assess work site perimeters. The criteria for defining a dangerous tree within the perimeter zone of a work site (but out of reach from direct disturbance by the activity), will be to find trees which are at risk of imminent collapse as for the dangerous tree criteria of LOD1. The exception would be if workers are entering the forested perimeters to perform other work activities.

Trees within the Perimeter Zone need to be viewed from the perspectives of:

- 1) Is the tree (or its part) within reach of the work site, and
- 2) Is it likely the tree could collapse without any disturbance?

If the answer to BOTH of these two conditions is YES, then the tree is a dangerous tree and it needs to be managed accordingly.

If the WDT assessor identifies a suspect tree that is within the Perimeter Zone, the assessor must review the tree amidst its surroundings and determine whether the tree poses an imminent hazard and whether the tree can reach the work site. The diligent WDT assessor must consider whether a tree having significant hazards has a sufficient buffer of trees to prevent the tree from reaching the work site. If there is sufficient screening to prevent the fall of a tree or its part from reaching the work site, then the tree is not a risk to workers.

Where there are steep slopes above the cutblock (e.g., >30%) the assessment of the perimeter area must be extended upslope of the treatment zone. The distance extended would depend upon site factors (e.g., slope, terrain complexity, tree size, stocking, crown structure, lean, etc) to detect trees with an imminent risk of failure that could fail and slide downslope into the treatment zone.

WDT Assessors need to make their assessment of both the treatment zone and the perimeter zone, and then communicate the safe work procedures to ensure trees are not disturbed during worker activities.

### **STEP 3: Conduct Tree Assessment**

#### **Visual Tree Inspection**

The determination of tree safety/danger is generally a visual process. Careful observation of tree defects can generally result in determination of an individual tree's failure potential and resultant safety decision within several minutes. However, where visual inspection identifies questionable root stability or shell thickness and where the results of the visual inspection are inconclusive, a detailed assessment involving root probing and/or stem sampling will be necessary.

## Detailed Tree Assessment

### A detailed assessment is required only if:

- visual inspection is inconclusive as to the safety of a tree; and
- the tree is planned for retention.

The following should be determined during detailed assessments:

1. Average stemwood shell thickness; and/or
2. Root condition.

### **NOTE:**

Results of the detailed tree assessment (e.g., actual sound stemwood shell thickness) can, in some cases, override the hazard rating determined from visual inspection of a particular tree defect. For example, the extent of decay due to an isolated conk at the base of a tree could be determined by increment-boring the affected area. However, this will generally be an exceptional practice.

## Tree Hazards

A tree can be potentially dangerous if it has defects in its top, branches, stemwood or root system. The degree of hazard will vary with the size of the tree, type and location of the defect, tree species, and nature of the target or work activity.

The wildlife/dangerous tree assessment process requires that assessors identify tree hazards and know how to recognize, evaluate and manage for all types of hazards.

### Live or dead tree defects

Tree defects can be separated into three categories: top and branch defects, stemwood defects, and root and butt defects.

Tables 3–5 provide a summary of tree defects associated with live or dead trees. On the following two pages are diagrams of each major tree defect.

## Common Dangerous Tree Indicators

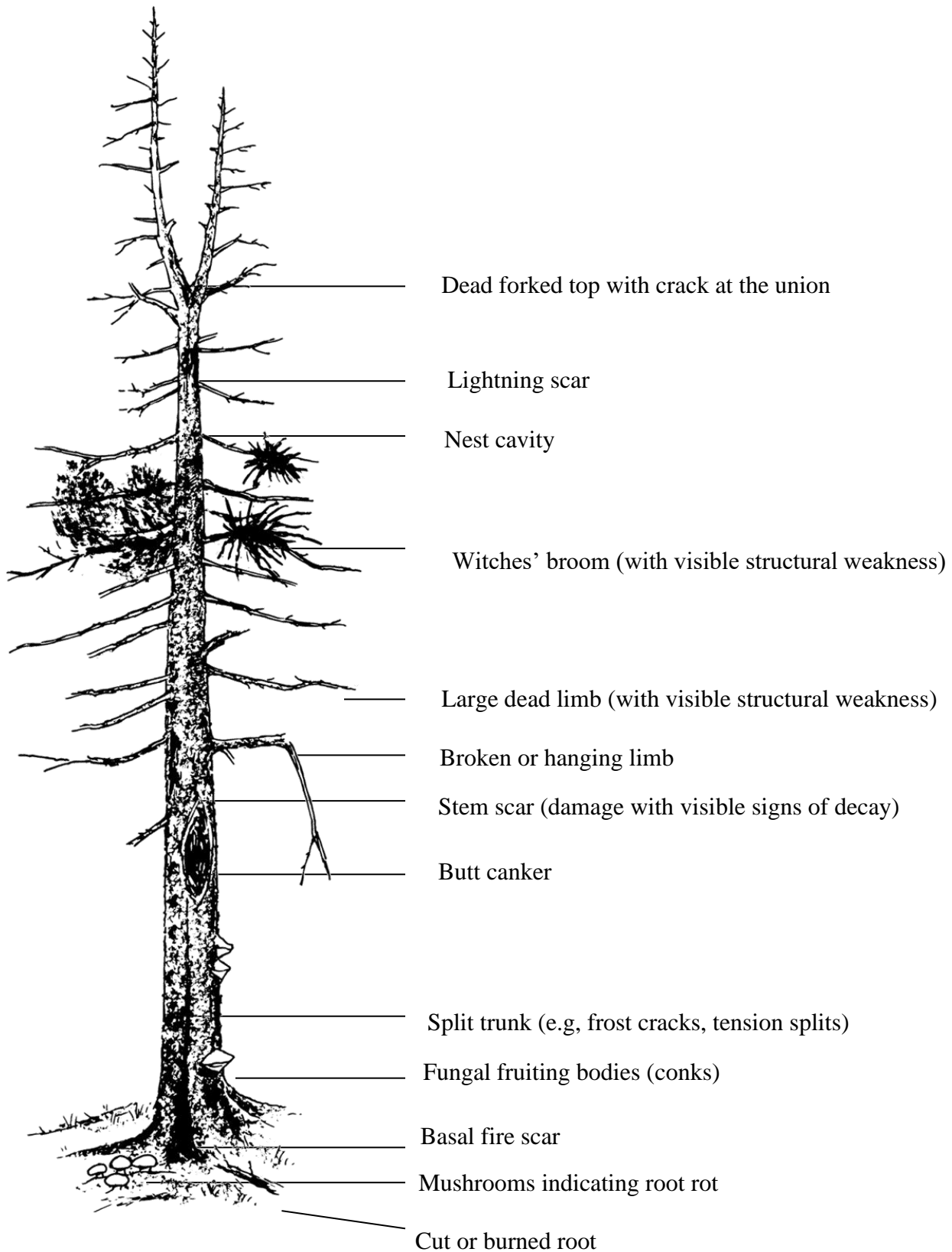

## Eight Generalized Tree Defects That Influence Tree Failure

(for further description, see Tables 3–5)

**Dead limbs (DL)**

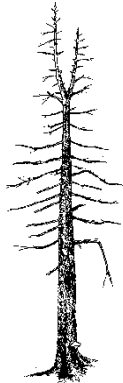

**Hazardous tops (HT)**



proportion of  
tree height



Secondary top that  
resulted from an  
old top breakage

**Witches' broom (WB)**

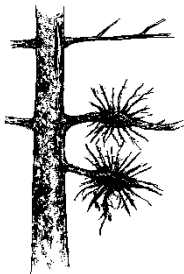

**Split trunk (ST)**

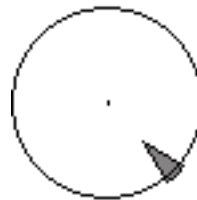

>2 cm width and  
>25% into stem



**Stem damage (scarring or butt rot) (SD)**



**Butt and stem cankers (CA)**



**Fungal fruiting bodies  
(conks and mushrooms) (CM)**

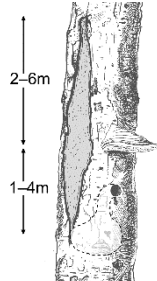

Heart rot decay  
column extending  
above and below conk.  
Distances indicated  
are a general rule of  
thumb. Circular  
woodpecker cavity  
nest hole indicates  
internal decay  
(drawing not to scale).

**Thick sloughing bark (SB)**



**Tree Lean** and **Roots** must also be evaluated as part of the Visual Inspection Process (STEP 3). Specific failure potential criteria for Tree Lean and Root inspection are described in Tables 3–5.

### Tree Lean

Tree lean may be recent or long-standing. Long-standing lean trees have often subsequently grown a vertical top in the time since the lean occurred. Live leaning trees develop tension and compression wood at stress points, to aid in support. They also develop a reinforced root system, where disturbed, to compensate for prior damage. Unless the roots are disturbed further or decay is present, the potential for failure of long-standing leaning trees is low, and such trees need not be considered a hazard.

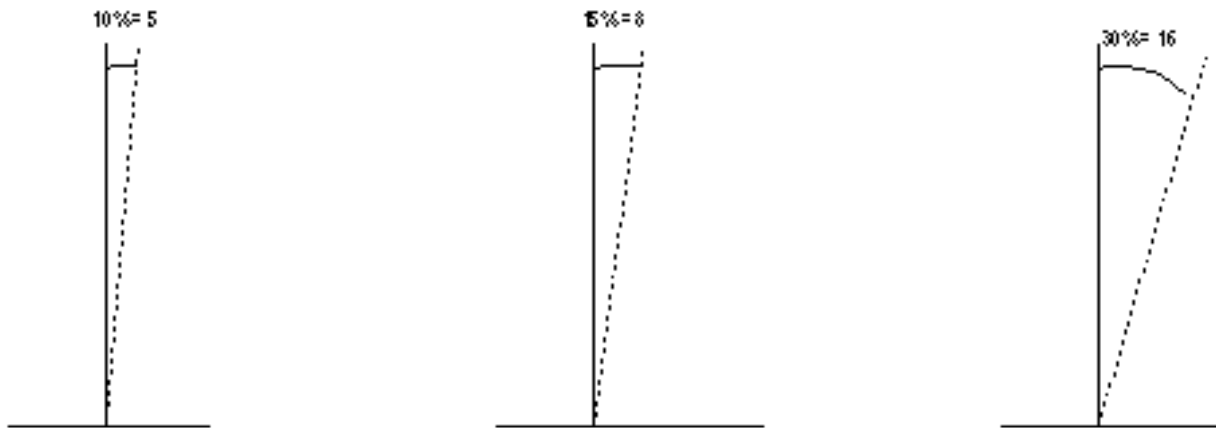

**Recently-leaning trees** are tilted over their entire length. Since there is no evidence of reinforcement of the root system or bole wood, assessors must assume potential hazard.

Assessors should also identify other rooting problems such as shallow roots or substrate, damaged or decayed roots, lifted roots, or history of windthrow.



**Sweep** is defined as the curvature or distortion of the stem, and is often associated with competition for sunlight, snowpack and steep slope conditions. Sweep should not be confused with lean. Sweep has no decay or soundness significance and is not a hazard indicator.

**Slope** is an important determinant of the direction of falling, and how far and with what force a tree will roll or slide after falling. Wildlife/dangerous trees falling on slopes may travel farther than the length of the tree.



**Stemwood Condition (only if required for Detailed Tree Assessment)**

The relative thickness of the outer solid shell or inner solid core of the tree in proportion to the tree's diameter provides an indication of the "columnar" strength. When the thickness of the shell or core of sound wood is insufficient for a tree's diameter, the failure potential can be said to be high. At least three cores should be taken from stems >40 cm diameter at sample height (DSH) to ensure that the required solid stem thickness is present. Look for signs of decay or weakness and bore the stem adjacent to those areas.

Trees with a sound average stemwood thickness <30% of the tree radius have a high failure potential (see Tables 4, 4A and 5) and are rated as Dangerous for stem condition.

**NOTE:** Sound wood is any wood that is firm, with no evidence of "punkiness." The wood is usually fairly light and uniform in colour, and growth rings are distinct. An increment core remains intact—it has a smooth texture and usually snaps when broken and doesn't easily dent or break under fingernail pressure.

**Caution:** In certain dead trees in Classes 3–7 (especially white and ponderosa pine), the sapwood often deteriorates more quickly than the heartwood. Carefully evaluate the depth of sapwood deterioration.

**NOTES:**

Diameter at Sample Height: This is the position on the tree where a defect is being evaluated with a detailed stem test or probe. If there is no detailed testing, then the sample height diameter will be recorded as the diameter of the tree at breast height (1.3m above the root collar known by many as DBH or diameter at breast height).

---

---

---

---

---

---

---

---



The procedure for determining stemwood condition compares the required shell thickness (RST) to the tree's actual solid shell thickness (AST) as follows:

1. Measure diameter at sample height (DSH); either at 30 cm above ground level (stump height) or at a specific position of weakness on the bole. This measurement is made outside the bark. For thick-barked Douglas-fir, ponderosa pine, western larch and cottonwood, a deduction for bark thickness should be made to determine the actual diameter of the stem. Most other tree species have relatively thin bark and do not need a deduction for bark thickness. An assessor, however, may make bark thickness deductions any time it is appropriate.
2. Divide the diameter inside bark by 2 to determine the stem's radius.
3. Multiply the radius by 0.3 to determine required shell thickness (RST). The RST is 30% of the tree radius ( $RST = \text{radius} \times 0.30$ ).
4. Bore tree at sample height or where the diameter was measured (average of two or more borings may be required) to determine the stem's actual solid shell thickness (AST).
5. Compare RST with AST. If the AST is equal to or greater than ( $\geq$ ) the RST, the stemwood condition is considered sound (S). If the AST is less than ( $<$ ) the RST, the stemwood condition is dangerous (D).

#### Example 1: tree with extensive heartrot

1. DSH = 70 cm
2.  $70 \text{ cm} \div 2 = 35 \text{ cm}$  radius
3.  $35 \text{ cm} \times 0.3 = 10.5 \text{ cm} = \text{RST}$ . The required shell thickness (RST) of this tree is 10.5 cm.
4. A core from this tree reveals that the outer shell of sound wood is 9 cm (the actual shell thickness or AST is 9 cm).
5.  $9 \text{ cm AST} < 10.5 \text{ cm RST}$ , therefore the stemwood condition of this tree is rated as dangerous (D).

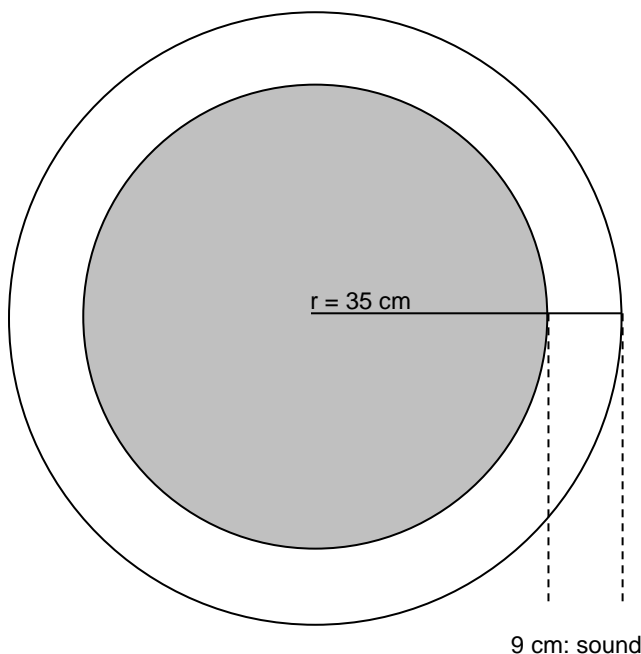

#### Example 2: tree with saprot decay and some inner heartrot

1. DSH = 32 cm
2.  $32 \text{ cm} \div 2 = 16 \text{ cm}$  radius
3.  $16 \text{ cm} \times 0.3 = 4.8 \text{ cm} = \text{RST}$ . The required shell thickness (RST) of this tree is 4.8 cm.
4. A core from this tree shows an unsound outer shell of 4 cm, and an unsound central core of 4 cm, with 10 cm of sound wood in between. The actual shell thickness (AST) is 10 cm.
5.  $10 \text{ cm AST} > 4.8 \text{ cm RST}$ , therefore the stemwood condition of this tree is rated as safe (S).

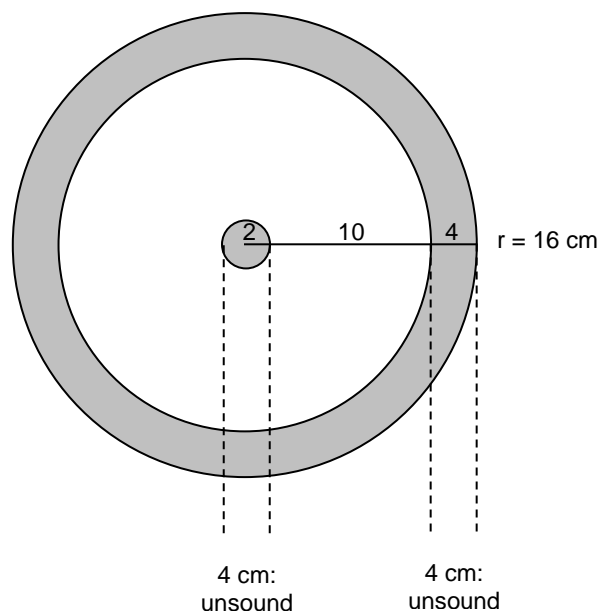

**Root Condition** (only if required for Detailed Tree Assessment)

Root condition is assessed at the root collar (as close to the ground as possible) using an increment borer or appropriate sharp probing instrument.

First, count the number of major lateral roots. Increment cores should then be taken until >50% of the major lateral roots are shown either to have advanced decay (>50% of roots circumference is decayed) or be free from decay (Example 1). Borings or probings are made into the lateral roots at a downward angle of  $\approx 45^\circ$  (Example 2). Root excavation and chopping into the roots with a Pulaski may cause unnecessary damage and destabilize the tree, thus this practice should be avoided.

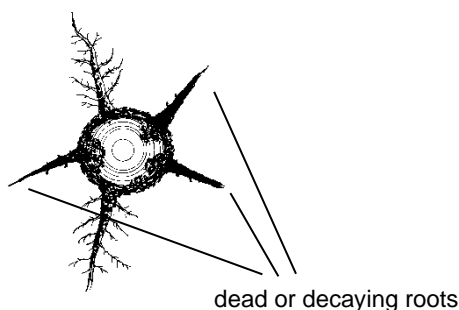
**Example 1:**

This tree has 5 major lateral roots. Cores were taken until it was found that 3 roots had advanced decay. The tree receives a Dangerous rating for root condition.

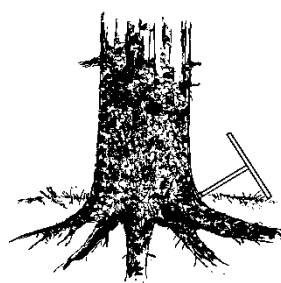
**Example 2:**

Core probes should be made at a  $45^\circ$  angle into the major lateral roots to assess root soundness. If possible, check the underside of the roots for any decay.

**NOTE:**

In general, trees have a high failure potential when **>50% of lateral roots have decayed more than 50% through; or when >50% of the root system has been mechanically disturbed, damaged or burned through.** Damaged root condition should not be confused with roots having the soil duff layer scraped or burned away, merely **exposing** the roots but not actually damaging them. For visual root inspection criteria, refer to Tables 3 - 5 for **the corresponding Level of Disturbance** (e.g., LOD 3 uses >25% root damage as the visual inspection criteria for danger rating).

- Wildlife/dangerous trees on shallow soils over bedrock or hardpan, or with high water tables, will have shallow root systems. Also look for root pull and cracked or lifting soil mats. These will become more hazardous over time and should be examined carefully before work activities begin.
- Trees growing in or near areas where root disease is present are likely to be infected as well. Watch for stand openings associated with uprooted trees, standing trees with thin or discoloured crown foliage, and fruiting bodies of root disease-causing fungi near the base of trees.

- Watch for leaning trees or trees on steep slopes which have damaged roots. Damaged roots on the “up-slope” or “up-lean” side of the tree increase the likelihood of tree failure, because under tension provide the greatest support for a tree. If these are weakened, the stability of the tree is at a higher risk of compromise.

Table 3 describes the **4 significant tree hazards which indicate a high failure potential and therefore a Dangerous rating for level 1 disturbance/work activities**— lesser hazards (as described in Tables 4–5) can be rated Safe for level 1 activities. In most cases a site assessment overview **conducted by a qualified person** will be sufficient to identify the significant tree hazards at level 1.

Table 3. Dangerous tree Assessment Process for Level 1 Disturbance Activities—Significant Hazard Indicators

<p><b>D = dangerous</b></p>	<p><b>D if tree has one or more of the following significant tree hazard indicators that are at risk of imminent failure*:</b></p> <ul style="list-style-type: none"> <li>• <b>Insecurely lodged trees or insecure hang-ups:</b> <ul style="list-style-type: none"> <li>i) Insecurely lodged trees (a tipped tree that is likely to shake free of the support trees and fall to the ground); or</li> <li>ii) Dislodged but hung-up limbs or tops (consider size and height above ground) at risk of shifting free during light winds or other tree motion</li> </ul> </li> <li>• <b>highly unstable tree:</b> Examples:                             <ul style="list-style-type: none"> <li>i) &gt;50% tree cross-sectional area damaged or decayed; or</li> <li>ii) Spongy snags with heart rot conks along the majority of the length of the stem (e.g., class 5-6 conifers or class 4 deciduous) or soft snags (e.g., class 7-8 conifers or class 5 deciduous); or</li> <li>iii) &gt;50% lateral roots damaged or with advanced decay</li> </ul> </li> <li>• <b>recent lean</b> toward work area AND decayed root system (&gt;50% of roots have advanced decay) or damaged and lifting anchoring soil layer (consider soil conditions and anchoring)</li> </ul>
<p><b>S = safe</b></p>	<p>all other trees</p>

\*Imminent failure: there is a high likelihood of failure during the operational period while workers are exposed.

The **qualified person must be sufficiently experienced and/or trained and mentored by a certified WDT Assessor to be able to recognize and ensure workers avoid exposure to the above significant hazards.** Crews should be instructed to keep a “heads-up” awareness for any of the 3 significant hazards and to stay away (generally greater than 1.5 defect lengths) from any trees showing these hazards. **However, any trees that the qualified person determines or suspects to be dangerous must be dealt with as follows BEFORE any workers enter that area:**

- have tree(s) or hazardous parts removed
- flag a no-work zone of appropriate size and shape around tree(s) and instruct workers to stay out of this area (generally 1.5 defect lengths in size).

**NOTE:** Work crews must also observe wind speed conditions. After winds exceed 40 km/h, crews cannot be near any trees which might be suspect unless they have first been rated as safe by a **certified dangerous tree assessor** for the equivalent wind speed rating (see Table 1A).

Weather conditions that may obscure potentially dangerous trees must also be considered when deciding whether a work crew may proceed on the site.

### **Structurally damaged sites**

A structurally damaged site is one that contains trees that have been severely and extensively damaged to the extent that a qualified person decides there is an undue risk of tree failure in the stand or site (e.g., under planting in a wildfire burn).

If work is required WITHIN 1.5 defect lengths of locations which are known or likely to contain defective, structurally damaged trees, then a qualified person must assess the work area PRIOR to work commencing in order to identify any trees which are dangerous and to implement the appropriate safety procedures.

### **NOTES:**

---

---

---

---

---

---

---

---

#### **NOTE**

**Tree defect descriptors that indicate a DANGEROUS tree rating are summarized in Tables 4 and 4A. Use these tables to determine which trees are rated dangerous for levels 2 and 3 disturbance activities respectively. Table 5 describes the only types of trees that are safe for retention in level 4 disturbance activities. The defects described in these tables are those that would likely cause injury if they were to fail. Therefore, consider the size of the defect and its height above ground.**

Table 4. Dangerous Tree Criteria for Level 2 Disturbance Activities

**NOTE:** Any tree defects as described in the boxes below will be rated as **DANGEROUS** for level 2 disturbance. Trees with lesser defects can be rated **SAFE** for level 2—care should be taken not to brush these trees and to fall and yard away if possible.

Defect Category	Species Group			
	Douglas-fir, larch, pines, spruces	Western redcedar, yellow cedar	Hemlock, true firs	Broad-leaved deciduous
<b>Hazardous top (HT)</b>	<ul style="list-style-type: none"> <li>Class 2 to 5 trees: Defective Top (any size; e.g., secondary top) where structural weakness is evident; OR</li> <li>Class 4 and 5 trees: defective top (e.g., secondary top) &gt;30% of tree height</li> </ul>	<ul style="list-style-type: none"> <li>Class 2 to 5 trees: Defective Top (any size; e.g., secondary top) where structural weakness is evident</li> </ul>	<ul style="list-style-type: none"> <li>Class 2 to 5 trees: Defective Top (any size; e.g., secondary top) where structural weakness is evident; OR</li> <li>Class 4 and 5 trees: defective top (e.g., secondary top) &gt;20% of tree height</li> </ul>	<ul style="list-style-type: none"> <li>Class 2 to 5 trees: Defective Top (any size) as a fork, co-dominant or multiple stem where structural weakness is evident; OR</li> <li>Where a dead top is &gt;20% of the tree height</li> </ul>
<b>Dead limbs (DL)</b>	<ul style="list-style-type: none"> <li>Dead limbs &gt;10 cm diameter with structural weakness</li> <li>Hung-up limbs</li> </ul>	<ul style="list-style-type: none"> <li>Dead limbs &gt;15 cm diameter with structural weakness</li> <li>Hung-up limbs</li> </ul>	<ul style="list-style-type: none"> <li>Dead limbs &gt;10 cm diameter with structural weakness</li> <li>Hung-up limbs</li> </ul>	<ul style="list-style-type: none"> <li>Dead limbs &gt;10 cm diameter (including "scaffold branching") with structural weakness</li> <li>Hung-up limbs</li> </ul>
<b>Witches' broom (WB)</b>	Brooms >1 m diameter on dead branches with evidence of decay, cracking or failure (dead branches and brooms may be on the ground)	n/a	Brooms >1 m diameter on dead branches with evidence of decay, cracking or failure (dead branches and brooms may be on the ground)	n/a
<b>Split trunk (ST)</b> (includes frost, lightning, wind-induced and impact-induced cracks)	Crack or split >2 cm wide extending >25% of tree diameter into stem AND evidence of advanced decay in surrounding stemwood	Crack or split >2 cm wide extending >50% of tree diameter into stem AND evidence of advanced decay in surrounding stemwood	Crack or split >2 cm wide extending >25% of tree diameter into stem AND evidence of advanced decay in surrounding stemwood	Crack or split >2 cm wide extending 25% of tree diameter into stem AND evidence of advanced decay in surrounding stemwood
<b>Stem damage (SD)</b> (includes scarring, fire damage, machine damage, animal damage or butt rot)	>25% of tree cross-sectional area damaged, burned, scarred or fractured	>50% of tree cross-sectional area damaged, burned, scarred or fractured	>25% of tree cross-sectional area damaged, burned, scarred or fractured	>25% of tree cross-sectional area damaged, burned, scarred or fractured
<b>Thick sloughing bark or sloughing sapwood (SB)</b> (bark applicable to Douglas-fir, larch, ponderosa pine and cottonwood >50 cm dbh)	Class 6–8 trees: Large pieces of bark or sapwood separated and sloughing from bole of tree*	<ul style="list-style-type: none"> <li>Bark n/a</li> <li>Long slabs of sloughing sapwood hanging from bole of tree</li> </ul>	n/a	Class 5 trees: Large pieces of bark separated and sloughing from bole of tree
<b>Butt and stem cankers (CA)</b>	>50% of butt or stem circumference as a perennial canker face	n/a	n/a	>50% of butt or stem circumference as a canker face on a dead tree
<b>Fungal fruiting bodies (CM)**</b> (conks and mushrooms)	<ul style="list-style-type: none"> <li>Any heartrot fungus present</li> <li>Exception: For veteran and dominant trees, if <i>Porodaedalea pini</i> conks present BUT NO other visible defects/damage to stem that allow oxygen exchange (e.g., broken top, scarring, nest cavity, etc.) = SAFE;</li> <li>Sap-rotting fungi present on any tree &lt;30 cm dbh where saprot depth is &gt;5 cm</li> </ul>	n/a	<ul style="list-style-type: none"> <li>Any heartrot fungus present</li> <li>Sap-rotting fungi present on any tree &lt;30 cm dbh where saprot depth is &gt;5 cm</li> </ul>	<ul style="list-style-type: none"> <li>Any heartrot fungus present;</li> <li>Exception: <i>P. tremulae</i> on live trembling aspen; apply alternate safe work procedures.</li> <li>Sap-rotting fungi present on any trees &lt;30 cm dbh where saprot depth is &gt;5 cm</li> </ul>
<b>Tree lean</b> (for class 1–3 trees)	Lean >15% toward target/work area AND tree has rooting problems (e.g., damaged roots; shallow, compacted or wet soils; cracked or lifting root mat; steep slope)	Lean >15% toward target/work area AND tree has rooting problems (e.g., damaged roots; shallow, compacted or wet soils; cracked or lifting root mat; steep slope)	Lean >15% toward target/work area AND tree has rooting problems (e.g., damaged roots; shallow, compacted or wet soils; cracked or lifting root mat; steep slope)	Lean >15% toward target/work area AND tree has rooting problems (e.g., damaged roots; shallow, compacted or wet soils; cracked or lifting root mat; steep slope)
<b>Tree lean</b> (for class 4–8 trees)	Lean >10% toward target/work area AND tree has rooting problems (e.g., damaged roots; shallow, compacted or wet soils; cracked or lifting root mat; steep slope)	Lean >10% toward target/work area AND tree has rooting problems (e.g., damaged roots; shallow, compacted or wet soils; cracked or lifting root mat; steep slope)	Lean >10% toward target/work area AND tree has rooting problems (e.g., damaged roots; shallow, compacted or wet soils; cracked or lifting root mat; steep slope)	Lean >10% toward target/work area AND tree has rooting problems (e.g., damaged roots; shallow, compacted or wet soils; cracked or lifting root mat; steep slope)
<b>Root inspection (RI)</b>	Occurrence of any of the following: root pull; lifting root mat; visible decay or damage to roots affects >50% of lateral roots	Occurrence of any of the following: root pull; lifting root mat; visible decay or damage to roots affects >50% of lateral roots	Occurrence of any of the following: root pull; lifting root mat; visible decay or damage to roots affects >50% of lateral roots	Occurrence of any of the following: root pull; lifting root mat; visible decay or damage to roots affects >50% of lateral roots.
<b>Detailed Tree Assessments</b>	STEM TEST: Average sound stemwood shell thickness <30% of tree radius (i.e., AST < RST) ROOT TEST: More than half of the roots are >50% decayed or rotten			

**NOTE:** Structural weakness includes visual evidence of decay, cracking, breakage, embedded bark or cracking at forks or multiple stem unions, presence of conks, stem scars, and woodpecker cavities.

\*\* If the identity of wood decay fungus cannot be determined (i.e., saprot or heartrot), then default to a Dangerous rating. Where *Porodaedalea pini* conks are present, if the stem has structural damage such as a broken top or scarring which allows oxygen exchange, or other stress indicators (e.g., resinosis, damaged roots), OR if there are conks distributed along the bole length, then default to a Dangerous rating.

Table 4A. Dangerous Tree Criteria for Level 3 Disturbance Activities

**NOTE:** Any tree defects as described in the boxes below will be rated as DANGEROUS for level 3 disturbance. Trees with lesser defects can be rated SAFE for level 3—care should be taken not to brush these trees and to fall and yard away if possible.

Defect Category	Species Group			
	Douglas-fir, larch, pines, spruces	Western redcedar, yellow cedar	Hemlock, true firs	Broad-leaved deciduous
<b>Hazardous top (HT)</b>	<ul style="list-style-type: none"> <li>Class 2 to 5 trees: Defective Top (any size; e.g., secondary top) where structural weakness is evident; OR</li> <li>Class 4 and 5 trees: defective top (e.g., secondary top) &gt;30% of tree height</li> </ul>	<ul style="list-style-type: none"> <li>Class 2 to 5 trees: Defective Top (any size; e.g., secondary top) where structural weakness is evident</li> </ul>	<ul style="list-style-type: none"> <li>Class 2 to 5 trees: Defective Top (any size; e.g., secondary top) where structural weakness is evident; OR</li> <li>Class 4 and 5 trees: defective top (e.g., secondary top) &gt;20% of tree height</li> </ul>	<ul style="list-style-type: none"> <li>Class 2 to 5 trees: Defective Top (any size) in the form of a fork, co-dominant or multiple stem where structural weakness is evident; OR</li> <li>Where dead top &gt;20% of tree height</li> </ul>
<b>Dead limbs (DL)</b>	<ul style="list-style-type: none"> <li>Dead limbs &gt;10 cm diameter with structural weakness</li> <li>Cracked, decayed, broken or hung-up limbs</li> </ul>	<ul style="list-style-type: none"> <li>Dead limbs &gt;15 cm diameter with structural weakness</li> <li>Cracked, decayed, broken or hung-up limbs</li> </ul>	<ul style="list-style-type: none"> <li>Dead limbs &gt;10 cm diameter with structural weakness</li> <li>Cracked, decayed, broken or hung-up limbs</li> </ul>	<ul style="list-style-type: none"> <li>Dead limbs &gt;10 cm diameter with structural weakness</li> <li>Cracked, decayed, broken or hung-up limbs</li> </ul>
<b>Witches' broom (WB)</b>	Brooms >1 m diameter on live or dead branches AND evidence of decay, cracking or failure	n/a	Brooms >1 m diameter on live or dead branches AND evidence of decay, cracking or failure	n/a
<b>Split trunk (ST)</b> (includes frost, lightning, wind-induced and impact-induced cracks)	Crack or split >2 cm wide extending >25% of tree diameter into stem AND evidence of decay in surrounding stemwood	<ul style="list-style-type: none"> <li>Class 2 and 3 trees: Crack or split &gt;2 cm wide extending &gt;50% of tree diameter into stem AND evidence of decay in surrounding stemwood</li> <li>Class 4–8 trees: Crack or split &gt;2 cm wide extending &gt;25% of tree diameter into stem AND evidence of decay in surrounding stemwood</li> </ul>	Crack or split >2 cm wide extending >25% of tree diameter into stem AND evidence of decay in surrounding stemwood	Crack or split >2 cm wide extending >25% of tree diameter into stem AND evidence of decay in surrounding stemwood
<b>Stem damage (SD)</b> (includes scarring, fire damage, machine damage, animal damage or butt rot)	<ul style="list-style-type: none"> <li>&gt;25% of tree cross-sectional area damaged, burned, scarred or fractured</li> </ul>	<ul style="list-style-type: none"> <li>Class 2 and 3 trees: &gt;50% of tree cross-sectional area damaged, burned, scarred or fractured</li> <li>Class 4–8 trees: &gt;25% of tree cross-sectional area damaged, burned, scarred or fractured</li> </ul>	<ul style="list-style-type: none"> <li>&gt;25% of tree cross-sectional area damaged, burned, scarred or fractured</li> </ul>	<ul style="list-style-type: none"> <li>&gt;25% of tree cross-sectional area damaged, burned, scarred or fractured</li> </ul>
<b>Thick sloughing bark or sloughing sapwood (SB)</b> (bark applicable to Douglas-fir, larch, ponderosa pine and cottonwood >50 cm dbh)	Large pieces of bark or sapwood separated and sloughing from bole of tree	Bark n/a <ul style="list-style-type: none"> <li>Long slabs of sapwood hanging from bole of tree</li> </ul>	n/a	Large pieces of bark separated and sloughing from bole of tree
<b>Butt and stem cankers (CA)</b>	>50% of butt or stem circumference as a perennial canker face *	n/a	n/a	<ul style="list-style-type: none"> <li>&gt;20% of butt or stem circumference as a perennial canker face*</li> <li>&gt;50% of butt or stem circumference as a canker face on a dead tree</li> </ul>
<b>Fungal fruiting bodies (CM)**</b> (conks and mushrooms)	<ul style="list-style-type: none"> <li>Any heart rot fungi present</li> <li>Exception: For veteran and dominant trees, if <i>Porodaedalea pini</i> conks present but no other defects or damage to stem that allow oxygen exchange (e.g., scars, broken top, nest cavity) = SAFE</li> <li>Sap-rotting fungi on trees &lt;30 cm dbh where saprot depth is &gt;3 cm</li> </ul>	n/a	<ul style="list-style-type: none"> <li>Any heartrot fungi present ; OR</li> <li>Sap-rotting fungi present on trees &lt;60 cm dbh where saprot depth is &gt;6 cm</li> </ul>	<ul style="list-style-type: none"> <li>Any heartrot fungi present;</li> <li>Exception: <i>P. tremulae</i> on live trembling aspen; apply alternate safe work procedures.</li> <li>OR</li> <li>Sap-rotting fungi present on trees &lt;60 cm dbh where saprot depth is &gt;6 cm</li> </ul>
<b>Tree lean</b> (for class 1–3 trees)	Lean >15% toward target/work area AND tree has rooting problems (e.g., damaged roots; shallow, compacted or wet soils; cracked or lifting root mat; steep slope)	<ul style="list-style-type: none"> <li>Lean &gt;15% toward target/work area AND tree has rooting problems (e.g., damaged roots; shallow, compacted or wet soils; cracked or lifting root mat; steep slope)</li> <li>For candelabra-branched trees, where candelabras are predominantly on lean side of tree—lean &gt;10% toward target/work area and tree has rooting problems</li> </ul>	Lean >15% toward target/work area AND tree has rooting problems (e.g., damaged roots; shallow, compacted or wet soils; cracked or lifting root mat; steep slope)	Lean >15% toward target/work area AND tree has rooting problems (e.g., damaged roots; shallow, compacted or wet soils; cracked or lifting root mat; steep slope)
<b>Tree lean</b> (for class 4–8 trees)	Lean >10% toward target/work area AND tree has rooting problems (e.g., damaged roots; shallow, compacted or wet soils; cracked or lifting root mat; steep slope)	Lean >10% toward target/work area AND tree has rooting problems (e.g., damaged roots; shallow, compacted or wet soils; cracked or lifting root mat; steep slope)	Lean >10% toward target/work area AND tree has rooting problems (e.g., damaged roots; shallow, compacted or wet soils; cracked or lifting root mat; steep slope)	Lean >10% toward target/work area AND tree has rooting problems (e.g., damaged roots; shallow, compacted or wet soils; cracked or lifting root mat; steep slope)
<b>Root inspection (RI)</b>	Occurrence of any of the following: root pull or lifting root mat; visible damage or decay to roots affects >25% of lateral roots	Occurrence of any of the following: root pull or lifting root mat; visible damage or decay to roots affects >25% of lateral roots	Occurrence of any of the following: root pull or lifting root mat; visible damage or decay to roots affects >25% of lateral roots	Occurrence of any of the following: root pull or lifting root mat; visible damage or decay to roots affects >25% of lateral roots.
<b>Detailed Tree Assessments</b>	STEM TEST: Average sound stemwood shell thickness <30% of tree radius (i.e., AST < RST) ROOT TEST: More than half of the roots are >50% decayed or rotten			

**NOTE:** Structural weakness includes visual evidence of decay, cracking, breakage, embedded bark or cracking at forks or multiple stem unions, presence of conks, stem scars, and woodpecker cavities.

\*\* If the identity of wood decay fungus cannot be determined (i.e., saprot or heartrot), then default to a Dangerous rating. Where *Porodaedalea pini* conks are present, if the stem has structural damage such as a broken top or scarring which allows oxygen exchange, or other stress indicators (e.g., resinosis, damaged roots), OR if there are conks distributed along the bole length, then default to a Dangerous rating

## Additional Notes Relevant to Tables 4, 4a and 5

### Structural Weakness

Structural weakness includes decay, cracking, breakage, embedded (included) bark or cracking at forks or multiple stem unions, presence of conks, stem scars, and woodpecker cavities.

### Nest Cavities

Nest cavities (which are usually circular in shape) should be considered as stem damage and is an indication **of internal decay**. However, some trees with nest cavities will have sufficient sound shell in this section of the tree, but this will vary with tree species and size, type of decay pathogen present, and other factors (e.g., other tree damage, site moisture, species of excavating bird, etc.). Assessors must therefore practice due diligence when evaluating trees containing cavity nests - these valuable wildlife trees warrant thorough assessment before concluding with the tree assessment.

### Perennial Cankers

Perennial cankers are generally circular to lens-shaped cankers that can persist for years, and slowly expand at about the same rate as the radial growth of the affected live tree. They gradually take on a sunken appearance, as tissues under the dead cambium do not grow with the surrounding wood. They are sometimes called “exploding cankers.”

### Identity of Wood Decay Fungi

If the identity of wood decay fungus cannot be determined (e.g., saprot or heartrot), then default to Dangerous rating.

- When *Porodaedalea pini* is present (see the exception note for the Douglas-fir, larch, pine, spruce conifer group) and the stem has structural damage such as a broken top or scarring that allow oxygen exchange or other stress indicators (e.g., resinosis, damaged roots), **OR** if there are conks distributed along the bole length, then default to Dangerous rating.
- With class 2 Aspen, when *Phellinus tremulae* is present, alternate safe work procedures can be used. This requires the assessor to perform a site review and to sample a selection of the trees in an attempt to determine what combination of defects results in failures at the site, and to use these criteria to define dangerous trees. If you do not see many broken or snapped aspen, conclude that **LIVE** standing aspen with **NO OTHER DAMAGE** other than visible conks, can be declared “Safe” to work around during the period of the work activity.
- If there is an isolated heart-rot conk on a live tree, the assessor can conduct a detailed assessment in vicinity of this conk to determine whether there is sufficient sound stemwood thickness to override the default dangerous rating. Such trees would then be monitored for decline and appearance of multiple conks (an indication that heart-rot has advanced and compromises stem wood strength). Refer to Appendix 1 for more detailed information about wood decay fungi, or consult reference resources that aid in recognizing fungi.

### Use of Cab-Guarded Machinery (FOPS Falling Object Protection System)

Machines guarded with FOPs cannot work in an area with unassessed and potentially dangerous trees. Prior to the machine working in an area with potentially dangerous trees either: i) the potentially dangerous trees must be assessed to ensure the tree is not dangerous to the operator for that LOD; or ii) a professional engineer certifies that the machine's FOPS has sufficient strength and coverage to protect the operator from a direct hit by the dangerous tree; or iii) a written variance to WCB Reg. 26.11(1) is obtained for a safety process that will afford equal or better protection than what is required by regulation.

Table 5. Dangerous tree Assessment Process for Level 4 Disturbance Activities

**When conducting level 4 disturbance assessments, only the following 4 types of trees are rated safe. All other trees will be rated Dangerous for level 4 activities.**

### Level 4 disturbance

#### S = Safe

if tree is one of the following:

- class 1 tree (all species)
- class 2 trees with NO structural defects (all species) (usually wind- or snow-snapped green trees, very light fire scorching).
- class 2 **cedars** with LOW failure potential defects (**refer to table at right**)
- class 3 **conifers** with NO structural defects (tree recently killed by insects, climate or light intensity fire—these will have no structural damage or decay)

**D = Dangerous** all other trees (fall tree; create a no-work zone; or remove hazardous parts)

Any leave tree that is damaged during the work activity must be reassessed if work is to continue within reach of the tree.

### CLASS 2 CEDAR TREES ARE SAFE IF THEY FIT THE FOLLOWING CRITERIA:

Defect Category	Western Redcedar, Yellow-cedar Low Failure Potential
<b>Hazardous top (HT)</b>	Defective Top (e.g. secondary top, spike) <30% of tree height with <b>no evidence</b> of decay, cracking, failure or other structural weakness
<b>Dead limbs (DL)</b>	Dead limbs (no size limit) with <b>no evidence</b> of decay, cracking or failure
<b>Split trunk (ST)</b> (includes frost, lightning and wind-induced cracks; does not include dry checking)	Crack or split >2 cm wide extending <50% of tree diameter into stem; <b>no evidence</b> of decay in surrounding stemwood
<b>Stem damage (SD)</b> (includes scarring, fire damage, machine damage, animal damage or butt rot)	<50% of tree cross-sectional area damaged, scarred or fractured with <b>no evidence</b> of decay in remaining stemwood
<b>Tree lean (TL)</b>	Lean <30% (16°) toward target/work area and tree has no rooting problems
<b>Lean — candelabra branched trees</b> (where candelabras are predominantly on lean side of tree)	Lean <10% (5°) toward target/work area and tree has no rooting problems
<b>Root inspection</b>	<b>No visible problems:</b> no root pull or lifting root mat. Any visible structural damage to roots only affects <25% of lateral roots (remaining roots undamaged)
<b>Average stemwood shell thickness</b> (for Detailed Tree Assessment if required)	Total sound stemwood shell thickness >30% of tree radius

**NOTE:** Structural Weakness includes visual evidence of decay, cracking, breakage, embedded (included) bark or cracking at forks or multiple stem unions, presence of conks, stem scars, and woodpecker cavities.





## Summary of Assessment Requirements

All work activities EXCEPT those defined as “very low risk” require a pre-work inspection by a qualified person to determine if there are any trees that might endanger workers. A summary of activity level assessment requirements is shown below. For a discussion of liability and dangerous tree assessments, see Appendix 5.

- **Very Low Risk (VLR) Activities**—No pre-work site inspection is required.
- **Level 1 Disturbance Activities**—A pre-work inspection by a qualified person is required. If trees with significant tree hazards (see Table 3) are observed, the appropriate safety procedures must be taken before work activities begin.
- **Level 2, 3 or 4 Disturbance Activities**—A pre-work inspection by a qualified person is required. However, if “suspect” trees (see Table 4, 4A, 5) are identified by a qualified person, then **further assessment by a certified dangerous tree assessor** is required and the appropriate safety procedures must be taken BEFORE work activities begin.



### NOTES:

---

---

---

---

## Inspection of Mechanically Cut Stubs

The following guidelines describe the dangerous tree inspection procedures for mechanically cut stubs and apply to all forestry activities. Stubs are **defined as artificially created wildlife trees that have been mechanically cut from Class 1, 2 or 3 trees.**

- Mechanically cut stubs that have been **cut from Class 1, 2 or 3 trees DO NOT require assessment** for any forestry activities.
- Generally, the condition of stubs on a cutblock will be determined as part of the general site overview. A qualified person will conduct a visual inspection of a few stubs to confirm the general age and condition of the stub trees. This should be a very quick process that serves to identify potential hazards, if any. For example, recently cut stubs from green trees will often be hazard-free. However, where there are naturally occurring stubs such as Class 7-8 trees, or where stubs have been cut from previously dead trees, these may be dangerous according to the “3 significant hazard indicators” (as per Table 3). The qualified person should be able to determine this information and then implement the appropriate safety procedures.
- The above requirements for level 1 activities apply to **NON-STRUCTURALLY DAMAGED** blocks/sites. However, stands that have been severely and extensively damaged by wildfire, to the extent that a qualified person decides there is undue risk of tree failure, must be considered to be structurally damaged. A structurally damaged stand must be assessed by a “certified dangerous tree assessor” before any work activities commence on site.
- There is **NO NEED** to map or track the location and condition of stub trees which have been left on the block and/or assessed.

## Dangerous Trees Along Roadsides

Potentially dangerous trees along and within reach of active roads should be assessed according to the appropriate level of disturbance (e.g., level 1 for heavy vehicle use on ballasted and compacted roads; see Table 1).

### Other factors to consider are:

- amount of lean toward road
- distance from road
- slope toward road
- rooting condition
- any hazardous tree defects (e.g., large dead top) that can reach the road.

## Alternate Safe Work Procedure for Decay Defects on Live Trembling Aspen

### **Rationale**

Trembling aspen (*Populus tremuloides*) are one of the most common deciduous trees that occur throughout the interior of British Columbia. Where it occurs, it is perhaps the most valuable wildlife tree for cavity excavating birds because of its propensity to develop heart rot decay as a live tree, relatively soon in its life span. In most cases this heart rot is caused by the fungi *Phellinus tremulae*, which is restricted to the heartwood of the tree and is often successfully compartmentalized by the tree. Consequently, depending on the diameter and vigour of the tree, the internal decay is restricted to the heartwood, with the tree developing a sound outer shell of later heartwood and sapwood. The result is a live tree which can often exhibit numerous fruiting bodies of *P. tremulae* (brownish-gray conks are usually visible just below branch stubs), yet have enough sound outer wood in the stem cross-section to provide columnar strength to the bole of the tree (i.e., the minimum required shell thickness is  $\geq 30\%$  of the tree radius). Trees in this condition make excellent nest sites for cavity excavating birds, and while they are still alive, often do not suffer stem breakage.

### **Related Dangerous tree Assessment Guidelines**

According to the tree failure criteria described in the *Wildlife/Dangerous tree Assessor's Course* modules, the presence of "... any heart rot fungi" found on broad-leaved deciduous trees results in a "Dangerous" rating under Level 2-4 work activities. However, most mature aspen have *P. tremulae* conks or blind conks - this means that these trees would automatically get a "D" rating if there is exposure to workers (except for Level 1 work activities). In some areas of the province where aspen is abundant, this may mean that an undue number of live and/or minimally damaged aspen would be rated "D" for Level 2-4 work activities - this would result in an unnecessary amount of tree felling and subsequent fuel loading in these situations, as well as a loss of wildlife habitat. An alternate job safety procedure is recommended for aspen, as follows:

### **Alternate Job Safety Procedure for Trembling Aspen (applicable to Level 2-4 work activities)**

1. **Conduct a site assessment overview** in order to determine the general size and condition of aspen in the work area
2. **Look for visible conks and blind conks** on tree trunks (usually seen as rough textured, blackish swellings at the base of branch stubs)
3. **Look for aspen trees that have broken or snapped.** If trees have sufficient decay to be a safety hazard (i.e., they have insufficient sound shell), then it is very likely that you will observe some broken and snapped trees, and trees with extensive woodpecker nest holes along the trunk.
4. If you do not see many broken or snapped aspen (with or without fire damage), then conclude that **LIVE** standing aspen with **NO OTHER DAMAGE** other than visible conks, can be declared "Safe" to work around during the period of the work activity.
5. **Document your observations** of aspen based on the site assessment overview
6. **Determine and document marking procedures** for aspen. If live aspen with conks are generally not breaking in the stand, then you will likely NOT have to mark aspen which have visible conks, but no other damage
7. The above 6 steps **ONLY apply to LIVE aspen** with visible conks or blind conks, **AND** which do NOT have other damage. Trees with other damage (e.g., fire scarring, dead tops, damaged roots, etc.) must be assessed according to Tables 3-5 and dealt with accordingly.

## NO-WORK ZONES (NWZ)

The purpose of a no-work zone is to protect workers from tree hazards in situations where the dangerous tree or parts thereof have not been removed.

**NWZs lengths are generally 1.5 times the defect length.  
This length can be modified (larger or smaller) depending on  
site-specific conditions such as slope or size of surrounding green timber.**

- When the decision has been made to retain a valuable wildlife tree that has been assessed as dangerous to workers, a no-work zone must be clearly identified and marked on site. The no-work zone must include all the area on the ground that could be reached by any dislodged portion of the tree.
- The shape of the no-work zone must accommodate the nature of the hazard and the lean of the tree.
- On steep ground, the no-work zone will be extended downhill to protect workers.
- No-work zones can be adjusted in size depending on the size of surrounding live timber (e.g., a small dangerous tree surrounded by much larger trees that “shield” the adjacent area have a NWZ radius less than 1.5 defect lengths).
- A kick-back area should be included for semicircular no-work zones. The size and shape of this area is determined by tree lean, condition and form (branching).

The most common types of no-work zones are illustrated on the following pages.

### NOTES:

---

---

---

---

---

---

---

---

**A. Sound tree, no lean, hazardous top, flat ground**

1. Determine the length of top that might dislodge.
2. Add  $\frac{1}{2}$  of this length, to get a  $1\frac{1}{2}$  top length distance.

This distance is the radius of the no-work zone.

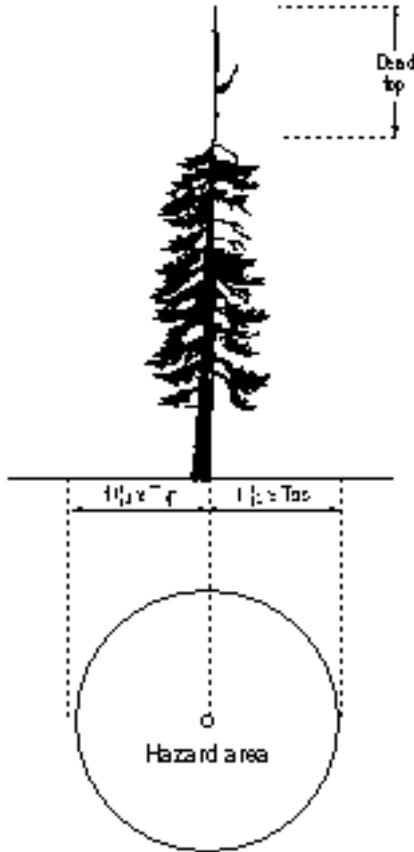

**B. Sound tree with lean, hazardous top, flat ground**

1. Determine the length of top that might dislodge.
2. Add  $\frac{1}{2}$  of this length, to get a  $1\frac{1}{2}$  top length distance.
3. Determine from the lean how far from the base of the tree the top might land.

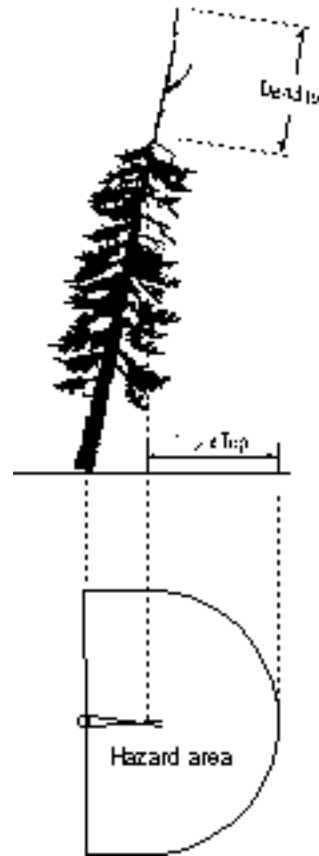

**C. Sound tree with lean, hazardous top, on slope**

1. Determine the length of top that might dislodge.
2. Add  $\frac{1}{2}$  of this length, to get a  $1\frac{1}{2}$  top length distance (horizontal distance from tree).
3. From the lean, determine how far from the base of the tree the top might land.
4. On slopes  $>30\%$ , extend the no-work zone downslope. This distance must be determined on a site-specific basis.

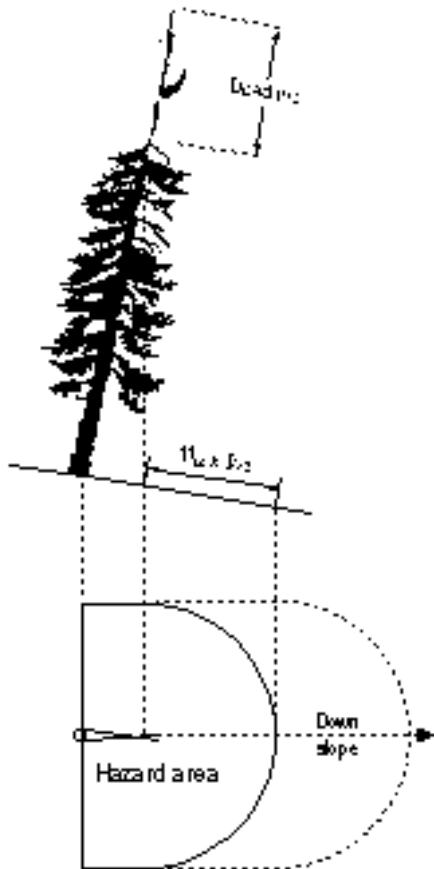

**D. Unsound or hazardous tree, no lean, flat ground**

1. Measure the height of the tree.
2. The no-work zone is a circle around the tree, with a radius of up to  $1\frac{1}{2}$  times the height.

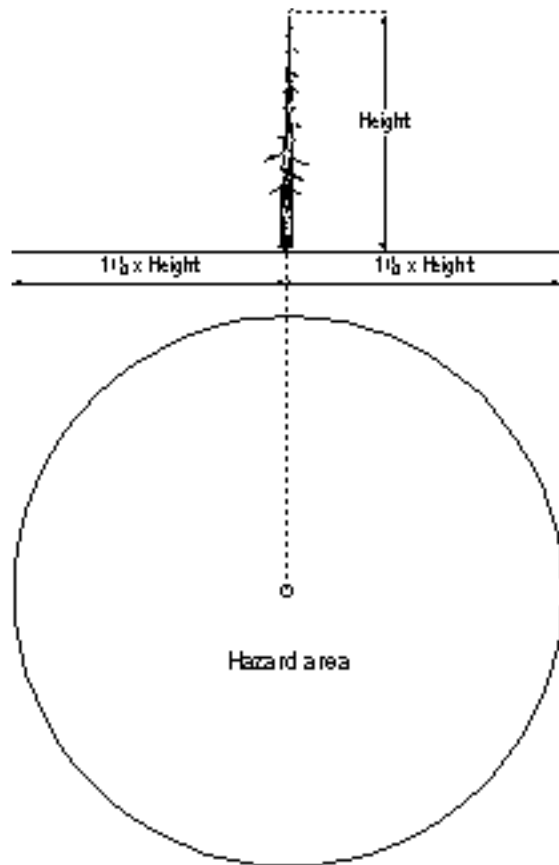

**E. Unsound or hazardous tree, with lean, flat ground**

1. Measure the height of the tree.
2. Add  $\frac{1}{2}$  of this length to get a  $1\frac{1}{2}$  tree length no-work zone.

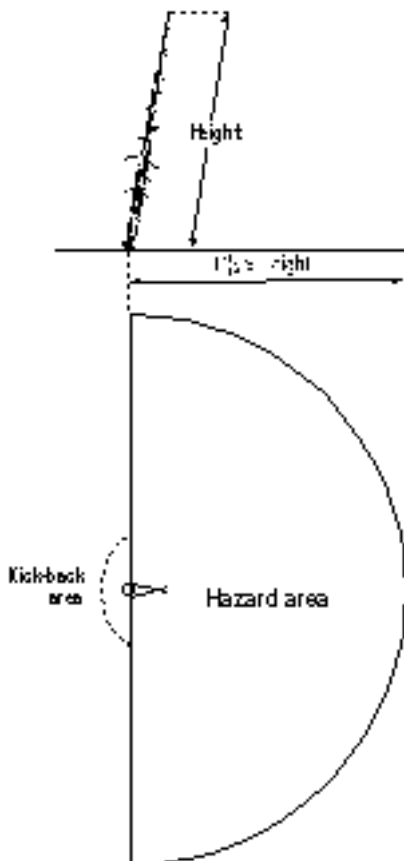

**F. Unsound or hazardous tree, with lean, on slope**

1. Measure the height of the tree.
2. The no-work zone is a half-circle extending up to  $90^\circ$  on each side of the lean, with a radius of  $1\frac{1}{2}$  times the height of the tree.
3. On slopes  $>30\%$ , extend the no-work zone downslope. This distance must be determined on a site-specific basis.
4. Trees on a  $>30\%$  slope need to be carefully assessed for their wildlife tree value, as the no-work zone will take up a large part of the treatment area.

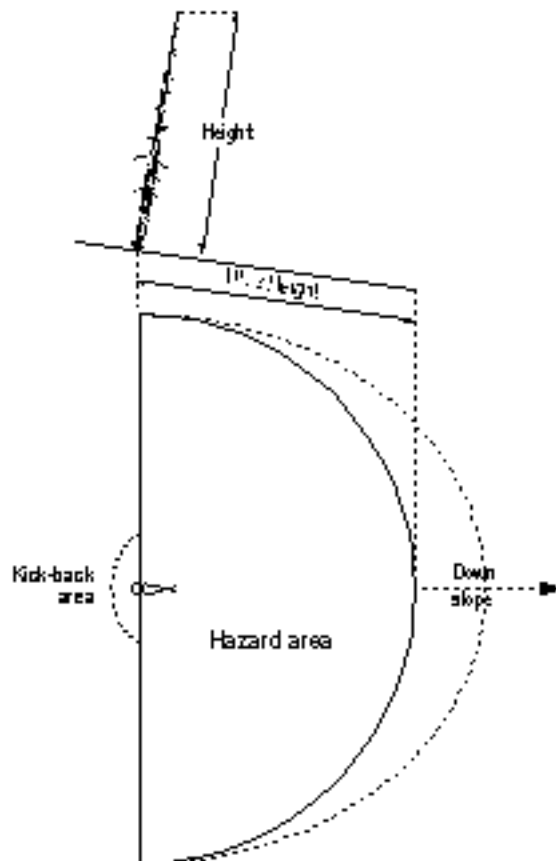



5. Where the tree slopes uphill, the no-work zone should be  $1\frac{1}{2}$  times the tree height going upslope.
6. Where the tree slopes uphill, depending on the slope of the hill, a kick back area will be added on a site-specific basis.

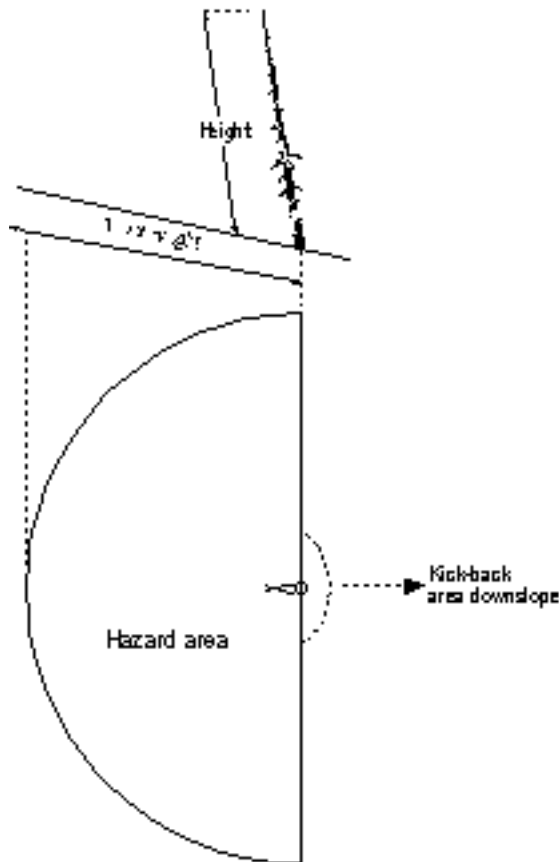

**G. Sound tree, no lean, defective branches**

1. Determine the length of defective limbs that might dislodge.
2. Add  $\frac{1}{2}$  of this length to get a  $1\frac{1}{2}$  limb length distance.

The  $1\frac{1}{2}$  limb length distance must be calculated for all defective limbs on the tree.

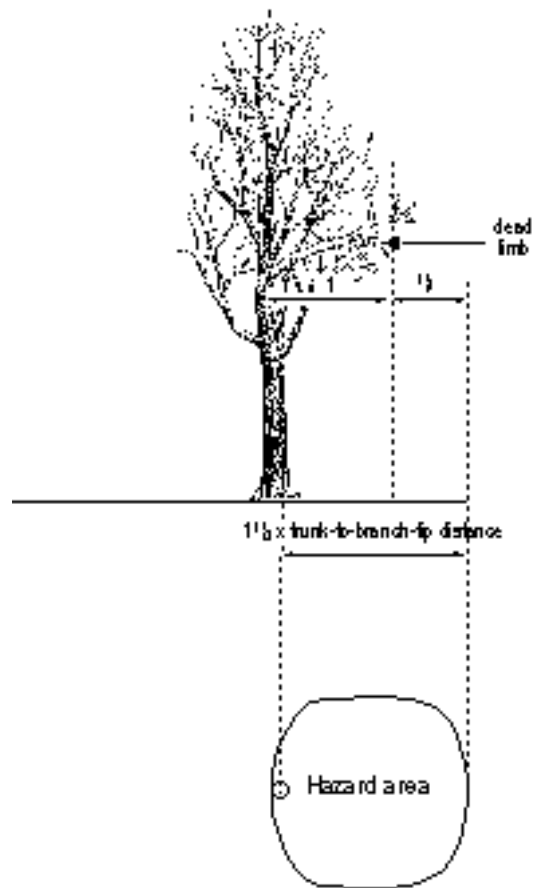

## Flagging No-work Zones

The assessor should ensure that all no-work zones are easily identifiable in the field.

Once the assessor has determined the size and shape of a no-work zone, the area should be flagged. When necessary, flag the inside of the no-work zone with a second color tape to indicate the centre. This will indicate the orientation of the NWZ to workers.

There are no compulsory flagging colors for NWZs. However, **the selected flagging color must be documented and communicated to workers** so that they will be able to identify NWZs in the field (see Documentation, STEP 4). Flagging should be placed at sufficient intervals so that workers will always be able to see the NWZ boundary from any position along its perimeter.

**No forest worker is allowed to enter the no-work zone EXCEPT to remove a specific tree hazard** (i.e., only a qualified dangerous tree faller can enter the NWZ in order to remove a dangerous tree adjacent to the work area).

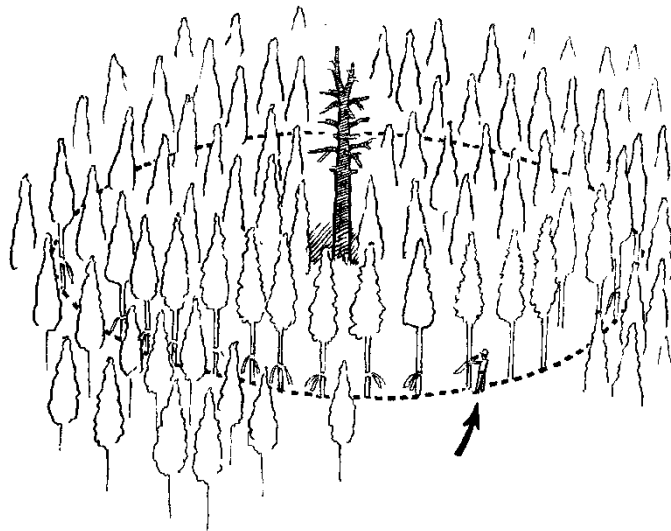

*Wildlife tree patches can function as a no-work zone, safely incorporating dangerous trees within or adjacent to the harvest setting.*

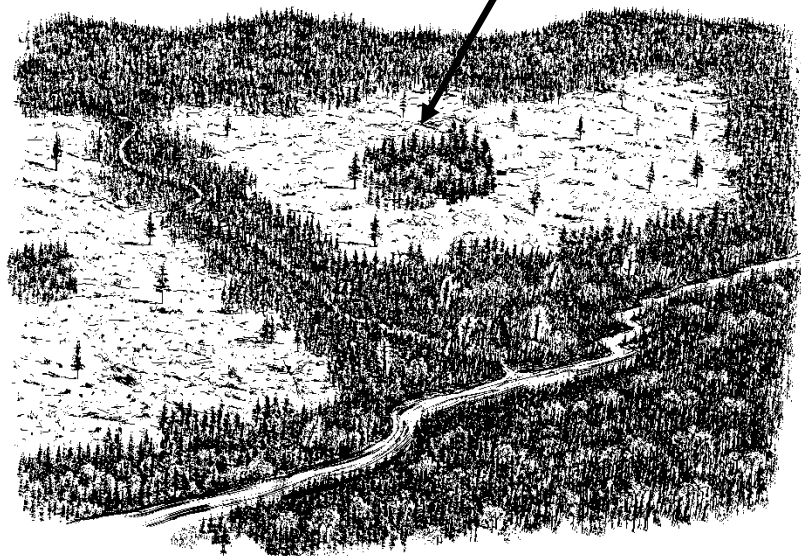

### Guidelines for Keeping or Removing Dangerous trees

- Use experienced fallers.
- Use explosives, where necessary, to fell dangerous trees too dangerous for hand-felling.
- If wildlife/dangerous trees are too dangerous to fell safely, install an appropriate-sized no-work zone around them.
- If no further treatment is expected, leave all wildlife/dangerous trees.
- Where feasible, fell all dangerous trees in main part of work area, especially in and along access and evacuation trails.
- Leave dangerous trees around perimeter if they lean sufficiently away from the present work area and not into an adjacent work area.
- Leave dangerous trees around ravines and gullies if lean is away from the work area.
- Remove dangerous trees above and below roads if they pose a potential hazard to road activity.

### Guidelines for Marking

All “suspect” and potentially dangerous trees assessed by a Qualified Person or a Certified Wildlife Dangerous tree Assessor must be documented in an acceptable manner (usually marked with tags, flagging or paint). There are **no compulsory colors of flagging or paint for marking** dangerous or safe trees. Generally, it is best to mark either the Safe trees or the Dangerous trees, depending on which is the lesser amount (i.e., in recently burned areas with high stem density where most of the trees are Safe, it is logical to mark only the Dangerous trees). In some situations it may be desirable to mark both the Safe and the Dangerous trees. Whichever method is used, **all people working in the area must be aware of the marking procedure and know the colors of flagging or paint used.**

The presence of a “Wildlife Tree” sign on a tree does not necessarily mean that the tree has been assessed as SAFE. **Wildlife tree signs are only intended to publicly identify trees having high habitat value for wildlife tree users.**



Marking a dangerous tree – do **NOT** paint “S” for Safe trees.

## STEP 5: Documentation and Communication

### Minimum documentation must include:

- Assessor's name
- Date and location of assessment
- Level of disturbance/type of work activity
- Marking procedures (i.e., tags, flagging or paint colors) used for assessed trees, assessed areas and no-work zones
- Locations of assessed trees and areas where assessments were completed
- Locations of no-work zones
- Use FS502 field cards if necessary to provide documentation on individual tree assessments
- Summary of pertinent site assessment overview factors used to guide tree assessment and safety planning (see Appendix 6 for sample field cards)

### Reassessment of Trees

Trees assessed and marked as SAFE must be reassessed if, prior to the work activity commencing, **an intervening winter or tree disturbance event (e.g., major windthrow, ice storm, fire), or if the level of disturbance has changed from the original assessment** (e.g., level 3 heli-log with grapple becomes level 4 heli-log with chokermen exposed to rotor wash).

### NOTES:

---

---

---

---

---

## Assessing Sites having a High Density of Dead or Damaged Trees

**OHS Regulation 26.11(3)** states that “if work in a forestry operation is to be carried out in an area that has more than 500 dangerous trees per hectare, the Board may approve a request to work without felling or assessing all the dangerous trees if, before the work starts,

- (a) A person who has completed a training program acceptable to the Board conducts a risk assessment of a representative sample of the dangerous trees, and
- (b) Any recommendations made in the risk assessment for eliminating or minimizing the risks are implemented.

In locations where there is a high density of “suspect or damaged trees” a certified and qualified Wildlife/Dangerous Tree Assessor must conduct a thorough site assessment overview and contribute to the development of a “points of control” process for the site. Assessors must identify the critical site limiting factors and stratify the worksite into appropriate LOD. Consultation with a local WorkSafe BC safety officer should be done as early as possible in the planning process to ensure the risk assessment process and proposed management strategies will be acceptable to the Board.

The risk assessment process for high stem density sites requires stratification of the proposed treatment area into strata having similar site limiting factors, defects, and treatment objectives. Within each stratum the assessor will then assess a representative sample of trees to determine their failure potential and create a mitigation strategy for the types of dangerous trees encountered. The mitigation strategy should be reviewed with WorkSafe BC, documented and fully implemented BEFORE workers are permitted to start treatments.

- In high density sites with dead or damaged trees that are **determined to have low levels of tree damage** (e.g., spike top cedar stands, low intensity burn damage, insect kill, or recently stem-girdled hardwoods), it may be more practical to mark the dangerous trees as “D” rather than marking the many safe trees. If so, this procedure must be documented and communicated to the appropriate workers.
- Once all dangerous trees are removed or placed within no-work zones, work is permitted around unmarked trees on the site. No-work zones must be flagged in the field and their locations mapped and/or communicated to workers on site.
- When conducting silviculture treatments in blocks having a high density of dead stems, a site evacuation plan must be prepared and included in your safety plan. Safety plans must stipulate wind thresholds, require continual monitoring of wind conditions, and provide a map of the evacuation routes for when wind speeds exceed the prescribed windspeed threshold. It may also require that worker refuge areas be created prior to work startup. The site evacuation plan will be verified on site by the job supervisor before crews commence work. The site evacuation plan must be present on-site along with the map indicating the location of no-work zones and safe refuge areas.

- **In some stands containing a high density of trees which have been dead beyond 7-10 years** (e.g., insect killed stands, old wildfire burn), tree conditions may have deteriorated to the point of extreme hazard risk. **In these areas a careful site assessment must be conducted in order to determine whether it is safe to conduct individual tree inspections and subsequent treatment of the site** (i.e., consider tree species, cause of death, tree conditions and extent of damage or decay, rooting condition and substrate, slope and wind exposure). The assessor must also consider the safety of the faller, as the vibration caused when trees hit the ground can cause other standing trees to fail.

### **Strategy for Managing Sites with a High Density of Dead or Damaged Trees**

In high stem density sites, such as wildfire burns or insect/disease areas, where potentially hundreds or thousands of standing dead or damaged trees remain, it is not practical to assess each tree for safety hazards. In this case, use pre-field stratification of the block to delineate wildlife tree patches (WTP) where stems can be retained. These areas will be no-work zones. WTPs facilitate assessment and retention of wildlife trees in those portions of high stem density blocks showing the greatest potential for wildlife habitat. An example of an area stratification is illustrated on the following page.

When stratifying the treatment area and establishing WTPs look for:

- areas containing large standing dead/burned stems; and
- areas near existing important habitat features such as valley bottom riparian zones, or mixed conifer and hardwood stands.
- WTPs should be flagged in the field (follow same procedure as for marking other NWZs), and their locations communicated to workers prior to work commencing in the area.

The size of WTPs will be determined by:

- the distribution/proximity of suitable wildlife trees, and according to the wildlife tree habitat for the site; and
- logistic variables (time and cost) associated with assessing individual stems in potentially large areas. Site treatment objectives play an important role in this decision.

All dangerous trees outside or along the edges of the WTPs or no-work zones should be felled before or concurrent with work activities in these areas. When assessing individual trees within each stratum, special care should be taken to assess the following variables, which are indicative of potentially hazardous situations:

- severity of the wildfire burn and time since tree death (note badly charred or damaged stems and root systems, including any indication of advanced decay as well as shallow, eroded soils around the tree base);
- areas with extensive decadence or extensive root disease issues;

- presence of stems that were standing dead trees prior to wildfire or insect outbreaks (these are often highly unstable); and
- site-specific conditions that affect stem stability and potential worker safety, including steep topography, wind exposure and moisture regime (wetter sites may accelerate the decay process).

Example of site stratification:

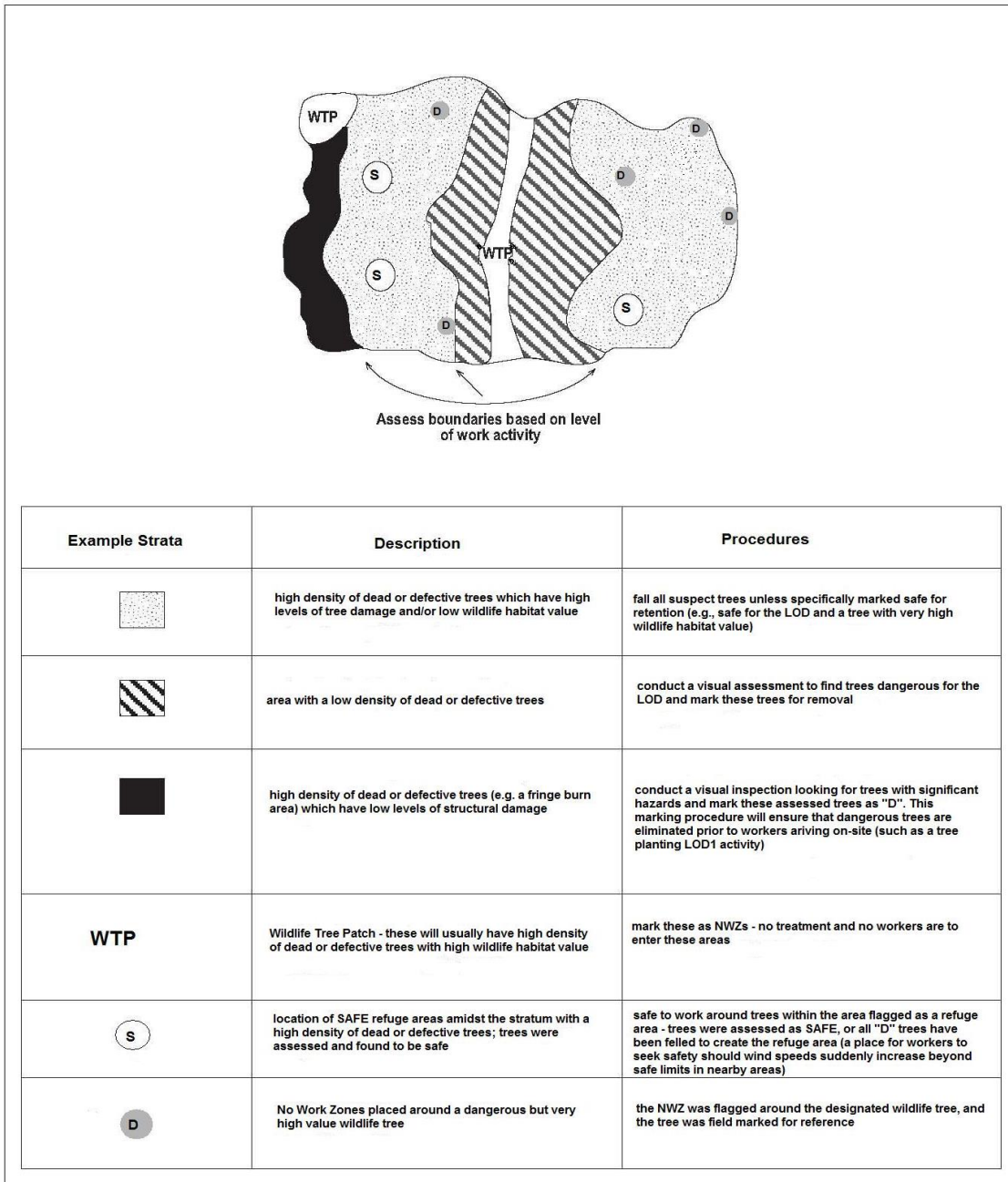





## REFERENCES AND GLOSSARY

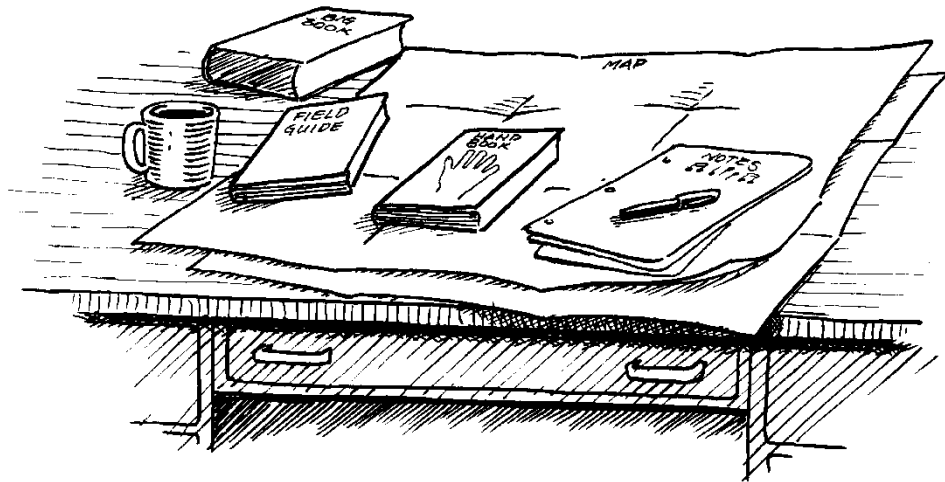



## REFERENCES

- Backhouse, F. and J.D. Lousier. 1991. Silviculture systems research: wildlife tree problem analysis. A report prepared for Silviculture Branch, Min. For. Victoria B.C.
- Bartels, R.J., R.L. Knight and G. Schaefer. 1985. Dead and down woody material. *In* E.R. Brown (ed.), Management of wildlife and fish habitats in forests of western Oregon and Washington. USDA For. Serv., Pac. NW Reg. Publication No. R-6-F&WL-192. 1985: 171–186.
- Bear den Registry, MoF, Report den structures to MoF for inclusion in the new Bear Den Database and subsequent studies. Send your data with subject “Black Bear” to: WCR.WildlifeData@gov.bc.ca.
- Big Tree Registry, UBC. <https://bigtrees.forestry.ubc.ca/> or obtain a registration package from: <https://bigtreesreg.sites.olt.ubc.ca/files/2014/04/BC-BigTree-Field-Package.pdf>
- British Columbia Ministry of Environment and Climate Change Strategy, Lands and Parks and Forestry Canada. Tree hazards in recreation sites in British Columbia. Management guidelines. Joint Report No. 13. Reprinted March 1992.
- Brown, E.R. (tech. editor). 1985a. Management of wildlife and fish habitats in forests of western Oregon and Washington: Part 1 - Chapter narratives. USDA For. Serv., Pac. NW Reg. Publication No. R6-F&WL-192-1985.
- Brown, E.R. (tech. ed.). 1985b. Management of wildlife and fish habitats in forests of western Oregon and Washington: Part 2 - Appendices. USDA For. Serv., Pac. NW Reg. Publication No. R6-F&WL-192-1985.
- Bull, E.L. 1977. Specialized habitat requirements of birds: snag management, old growth, and riparian habitat. PNW-64.
- Bull, E.L., J.W. Thomas, and K. Horn. 1986. Snag management on national forests in the Pacific Northwest — 1984. *West. J. Appl. For.* 1(2):41–43.
- Bunnell, F.L., B. Booth, and A.C.M. Farr. Bald eagles. Brochure. Outdoor Canada, Wildlife Habitat Canada, World Wildlife Fund and B.C. Environment, Victoria, B.C. Copies available from B.C. Environment.
- Campbell, W.R., N.K. Dawe, I. McTaggart-Cowan, J.M. Cooper, G.W. Kaiser, and M.C.E. McNall. 1990. The Birds of British Columbia - Volumes 1 and 2. Royal B.C. Museum, Victoria, B.C.
- Campbell, W.R., K.H. Morgan, and C. Palmateer. 1988. Species notes for selected birds. Vol. 2 *In*: A.P. Harcombe (tech. editor) Wildlife Habitat Handbooks for the Southern Interior Ecoprovince. Min. Envir. and Min. For., Victoria, B.C.
- Cannings, R.A. and A.P. Harcombe (editors). 1990. The vertebrates of British Columbia: scientific and English names. Royal B.C. Museum Heritage Record No. 20; Wildlife Rep. No. R24. Min. Mun. Affairs, Rec. and Culture and Min. Envir., Victoria, B.C.

- Cline, S.P., A.B. Berg, and H.M. Wight. 1980. Snag characteristics and dynamics in Douglas-fir forests, western Oregon. *J. Wildl. Manage.* 44(4):773–786.
- Cowan, I.M. and C.J. Guiget. 1965. *The Mammals of British Columbia*. B.C. Prov. Museum, Victoria, B.C.
- Culturally Modified Trees of BC. A Handbook for the Identification and Recording of Culturally Modified Trees. 2001. Archaeology Branch B.C. Ministry of Small Business, Tourism and Culture for the Resources Inventory Committee.
- Dunster, J.A. and S.M. Murray. 1997. *Arboriculture and the law in Canada*. Intl. Soc. Arboriculture, Savoy, Ill.
- Ehrlich, P., D. Dobkin, and D. Wheye, 1988. *The Birder's Handbook: A Field Guide to the Natural History of North American Birds*. Simon & Schuster/Fireside Books, New York, N.Y.
- Fenger, M., T. Manning, J. Cooper, S. Guy, P. Bradford. 2006. *Wildlife & Trees in British Columbia*. Lone Pine Publishing. Vancouver, BC.
- Finck, K.E., P. Humphreys, and G.V. Hawkins. *Field guide to pests of managed forests in British Columbia*. Min. For. and For. Can. Joint publication No. 16.
- Fischer, W.C. and B.R. McClelland. 1983. A cavity-nesting bird bibliography — including related titles on forest snags, fire, insects, disease, and decay. USDA For. Serv., Gen. Tech. Rep. INT-140, Intermtn. For. and Range Exp. Stn.,
- Frissell. S. 1984. The impact of firewood cutting on hole-nesting birds. *West. Wildlands*. (4):28-30.
- Glinski, R.L., T.G. Grubb, and L.A. Forbis. 1983. Snag use by selected raptors. pp. 130-133 *In: Snag habitat management: proceedings of the symposium*. USDA For. Serv., Gen. Tech. Rep. RM-99, Rocky Mtn. For. and Range Exp. Stn.
- Green, D.M. and R.W. Campbell. 1984. *Amphibians of British Columbia*. B.C. Prov. Museum Handbk. No. 45.. Victoria, B.C.
- Harvey, R.D. and P.F. Hessburd. 1992. Long range planning for developed sites in the Pacific Northwest: the context of hazard tree management. USDA For. Serv., Pac. NW Region, FPR-TP039-92.
- Keisker, D.G. 1987. Nest tree selection by primary cavity-nesting birds in south-central British Columbia. B.C. Min. Envir. and Parks, Wildlife Rep. No. R-13.
- Klinka, K., R.E. Carter, and M.C. Feller. 1990. Cutting old-growth forests in British Columbia: ecological considerations for forest regeneration. *Northwest Environ. J.* 6: 221–242.
- Machmer, M.M. and C. Steeger. 1995. The ecological roles of wildlife tree users in forest ecosystems. *Land Management Handbook 35*. Min. For. , Victoria.
- Matheny, N. and J. Clark. 1991. Evaluation of hazard trees in urban areas. *Int. Soc. Arboric., Urbana*, Ill.
- Matthews, J.D. 1989. *Silviculture systems*. Clarendon Press, Oxford.
- Maser, C. 1988. *The redesigned forest*. R.E. Miles, San Pedro, CA.

- Nagorsen, D. W. and R.M. Brigham. 1993. Bats of British Columbia. Royal British Columbia Museum Handbook. Vol. 1. The mammals of British Columbia. UBC Press, Vancouver, B.C.
- Neitro, W.A., R.W. Mannan, D. Taylor, V.W. Binkley, B.G. Marcot, F.F. Wagner, and S.P. Cline. 1985. Snags. pp. 129–169 *In: Management of Wildlife and Fish Habitats in Forests of Western Oregon and Washington. Part 1 — Chapter Narratives.* Browne, E.R. (tech. editor). USDA For. Serv., R6-F&WL-192- 185, Pac. NW Reg.
- Stevens, V. and S. Lofts. 1988. Species notes for mammals. Vol. 1 *In: Wildlife habitat handbooks for the Southern Interior Ecoprovince.* A.P. Harcombe (tech. editor). Min. Envir. and Min. For., Victoria, B.C.
- Thomas, J.W., R.G. Anderson, C. Maser, and E.L. Bull. 1979. Snags. pp. 60-77 *In: Wildlife Habitats in Managed Forests: The Blue Mountains of Oregon and Washington.* USDA For. Serv. Handbk. 553.
- Wagener, W.W. 1963. Judging hazard from native trees in California recreational areas: a guide for professional foresters. USDA For. Serv. Res. Paper PSW-P1.
- Wildlife Branch. 1990. Managing wildlife to 2001: a discussion paper. B.C. Min. Envir., Lands and Parks, Victoria, B.C.
- Wildlife Tree Committee of British Columbia. 1993. A bibliography on wildlife trees for British Columbia with annotations and abstracts. B.C. Wildlife Tree Committee and B.C. Min. Envir. Victoria, B.C.
- Workers' Compensation Board of British Columbia (WCB). 1998. Occupational health and safety regulation, Parts 20–33. April 1998. Richmond, B.C.
- Zarnowitz, J.E. and D.A. Manual. 1985. The effects of forest management on cavity-nesting birds in northwestern Washington. *J. Wildl. Manage.* 49(1):255-263.

## GLOSSARY

For the purposes of this text, the following terms and definitions will be used:

<b><i>biogeoclimatic subzone</i></b>	A representative class of ecosystem under the influence of the same regional climate. It is associated with a distinct climax (or near-climax) group of plants. For example, the Sub-Boreal Spruce Moist Cool (SBSmk) subzone is characterized by a hybrid spruce-huckleberry-highbush cranberry plant association.
<b><i>biological diversity</i></b>	The diversity of plants, animals and other living organisms in all their forms and levels of organization, including genes, species, ecosystems, and the evolutionary and functional processes that link them.
<b><i>blind conk</i></b>	Sometimes called swollen knots; are significant indicators of decay. They typically appear as pronounced swellings around knots and are the result of the tree attempting to heal over an old conk. Often the affected knot and new conk is partially covered by sound wood, which is implied by the term "blind" conk.
<b><i>canker</i></b>	Dead portion of the cambium and bark on a branch or the main stem. Cankers can be raised or sunken and are sometimes surrounded by a raised lip of tissue.
<b><i>certified dangerous tree assessor</i></b>	Someone who has passed one or more of the Wildlife/Dangerous tree Assessor's course modules sponsored by the Wildlife Tree Committee of B.C., and who holds a valid certificate which signifies this designation.
<b><i>chlorotic</i></b>	Yellowing of normally green foliage tissue due to lack of chlorophyll. Usually indicates poor growing conditions or some sort of tree stress (e.g., root disease).
<b><i>coarse woody debris (CWD)</i></b>	Fallen trees or logs, and parts of trees on the forest floor. CWD provides habitat for various small mammals, salamanders and numerous invertebrates. As it decays, it provides nutrients back to the forest soil.
<b><i>Culturally modified tree (CMT)</i></b>	A CMT is a tree that has been altered by aboriginal people as part of their traditional use of the forest.
<b><i>conk</i></b>	The fruiting body of a wood decay fungus; bracket-like or reclined or flat on the host or ground, but not a mushroom. Usually woody or leathery in texture.

<b><i>dangerous tree</i></b>	Means a tree that is a hazard to a worker due to its location or lean, its physical damage, overhead conditions, deterioration of its limbs, stem or root system, or any combination of these conditions.
<b><i>defect length</i></b>	The length of the dangerous defect on a tree; this could be the dangerous dead limb, or hazardous top (i.e., the segment above an observed weakness), or the entire tree (i.e., the whole tree is at risk of failure because of root problems, lean or insufficient stem thickness).
<b><i>dominant trees</i></b>	The tallest trees of the main forest canopy layer.
<b><i>embedded (included) bark</i></b>	Bark that is pushed inside a developing branch or stem crotch, usually causing visible cracking and a weakened structure.
<b><i>environmentally sensitive area (ESA)</i></b>	An area with potentially fragile or unstable soils that may deteriorate unacceptably after forest harvesting, or one of high value for non-timber resources such as fisheries, wildlife, water and recreation.
<b><i>forest activity</i></b>	Any activity that requires workers to be in the field where they may be in the vicinity of living or dead trees.
<b><i>guild</i></b>	A group of species with similar behaviors and similar ecological requirements (e.g., cavity-nesting ducks).
<b><i>habitat</i></b>	A specific kind of living space or environment that provides at least minimal conditions for one organism to live, or for a group to appear together.
<b><i>hazardous top</i></b>	A suspect or defective top section (live or dead) of a tree that may be hazardous because of visible structural weakness, especially if there is evidence of decay or cracking. The defect length is defined by the point of visible stem deformation (stem swelling or goiter, spike, multi-tops or candelabra, fork, kink or other such deformity) or stem damage that makes the top prone to failure.
<b><i>live cull</i></b>	A live tree with some visible external defect such as a broken, dead, or forked top, split or scarred trunk, or fungal conks.
<b><i>live class 1 tree</i></b>	A living, growing tree with good vigour, no structural problems, and no visible signs of disease or decay.
<b><i>no-work zone (NWZ)</i></b>	A flagged area where no worker shall enter except to remove hazards. Workers will be informed about no-work zones prior to commencement of work on site. The size of NWZs is 1.5 times the defect length. This length can be modified (larger or smaller) depending on site-specific conditions.

<b>old growth</b>	A forest that contains live and dead trees of various sizes, species composition, and age class structure that are part of a slowly changing but dynamic ecosystem. The age at which forests develop the specific structural attributes that characterize old growth will vary widely according to forest type, climate, site characteristics and disturbance regime. Old growth is typically distinguished from younger stands by several of the following attributes: large trees for species and site; wide variation in tree sizes and spacing; accumulations of large, dead standing and fallen trees; multiple canopy layers; canopy gaps and understory patchiness; decadence in the form of broken or deformed tops or boles; and root decay.
<b>pathogen</b>	A living organism that incites disease in a host.
<b>pre-harvest</b>	Prior to harvesting activity.
<b>qualified person</b>	A person experienced in the specified work activity and who, by reason of education, training, experience or a combination thereof, is able to recognize and evaluate hazards associated with trees under the mentoring of a certified WDT Assessor, with due regard for the anticipated work activity and possible disturbance of the tree(s).
<b>raptor</b>	A bird of prey such as an eagle, hawk, falcon or owl.
<b>recruitment</b>	Wildlife tree management strategy of retaining standing live or dead trees that will become future wildlife trees.
<b>regeneration cut (reproduction method)</b>	The manner in which a stand is cut to ensure the establishment of a replacement stand of a desired composition, vigour and structure within a certain time limit.
<b>reserve</b>	The retention of a various number of unharvested (reserved) trees, distributed either uniformly or in groups for purposes other than regeneration. Some of these purposes include wildlife habitat, biological diversity, and aesthetics. Reserves can be used with any silvicultural system. For purposes of wildlife tree management, a reserve can range in size from a single, outstanding wildlife tree, to a patch containing many wildlife trees on several hectares.
<b>resinosis</b>	An abnormal flow of resin or pitch from conifers, often from the base or lower stem. Resinosis can indicate the presence of tree pathogens or damage.
<b>riparian area</b>	The land bordering a river, stream, lake, reservoir, pond, wetland or spring. Riparian areas typically exemplify a rich and diverse vegetative mosaic reflecting the influence of available surface water.



<b><i>rust</i></b>	A disease caused by infection with one of the rust fungi, often producing yellow to orange spores at some point during the infection.
<b><i>saprot fungi</i></b>	A general group of fungal organisms which decay in the outer sapwood layer of trees. Saprots tend to be more commonly found on dead trees. Because of their shallow depth of penetration (2 cm – 5 cm is usual), they generally only contribute to tree structural failure on small diameter dead trees (e.g., <30 cm dbh).
<b><i>scaffold branching</i></b>	Multiple stem and branch attachments characteristic of some deciduous trees. They consist of a system of co-dominant branches and lack a central leader.
<b><i>secondary top</i></b>	A growth leader on a tree which usually forms after the breakage or die-back of the original tree top. Secondary tops (live or dead) can occur as single leaders, forks or multiple tops. They may be hazardous, especially if there is <b>evidence of decay or cracking at the point of the original top breakage or stem deformity</b> .
<b><i>seral stage</i></b>	One of a chain of successional ecological stages leading to a climax plant community. For example, an early seral stage could be a grassy meadow or clearcut, a mid-seral stage could be a mixed hardwood/conifer forest, and a late seral stage could be a mature or old-growth forest.
<b><i>silvicultural system</i></b>	A cycle of activities by which a forest stand, or group of trees, is harvested, regenerated and tended over time. These activities include harvesting, site preparation, reforestation and stand tending.
<b><i>site plan (SP)</i></b>	A planning system for collecting site-specific field data and developing forest management prescriptions before harvesting is undertaken.
<b><i>sloughing</i></b>	Starting to separate and eventually falling or breaking away from the tree trunk.
<b><i>spike top</i></b>	The pointed <b>dead tip of a living tree</b> from which most of the needles and branches have fallen off. The length of this “spike-shaped” dead tip is variable and can sometimes be up to 1/3 or more of the tree height for species such as cedars. This top dieback may be caused by insects, disease, or climatic factors.
<b><i>stand level</i></b>	The level of forest management at which a relatively homogeneous land unit can be managed under a single prescription, or a set of treatments, to meet well-defined objectives.

<b><i>stand-level structural attributes</i></b>	Components of a forest stand (including living and dead standing trees, canopy architecture and fallen dead trees) which together determine stand structure.
<b><i>stand management prescription</i></b>	A planning document to describe how treatments to a free-growing site will ensure meet stated objectives; maintain productivity of the site; ensure resource values including biological diversity are identified and accommodated; and outlines the series of activities.
<b><i>stratification</i></b>	Dividing or organizing an area, such as a cutblock, into distinct units based on site-specific factors such as treatment objectives, vegetation type or physiography.
<b><i>structurally damaged stand</i></b>	A stand of trees which has been severely and extensively damaged, to the extent that a qualified person decides there is an undue risk of tree failure in the whole stand or site.
<b><i>stub</i></b>	An artificially-created wildlife tree, mechanically cut from a class 1, 2 or 3 tree.
<b><i>suppression</i></b>	Reduced tree growth and vigor due to excessive competition for light, moisture and nutrients.
<b><i>suspect tree</i></b>	Suspect trees are <i>any live or dead tree with a visible defect which could cause failure of the tree, either whole or in part, for the applicable level of disturbance</i> . Suspect trees require a visual inspection in the context of a site assessment by a qualified person or a certified WDT assessor, in order to determine whether they are dangerous for a particular level of disturbance/type of work activity.
<b><i>uneven-aged management</i></b>	A silvicultural system designed to create, maintain and regenerate an uneven-aged stand structure (a stand of trees consisting of three or more age classes). Single tree and group are uneven-aged silvicultural systems.
<b><i>veteran tree</i></b>	A tree which is significantly older (usually 150 years of age or greater) than the trees of the main forest canopy. The tree may have survived one or more fires as evidenced by fire scars. Veteran trees are usually isolated in distribution and often extend well above the main tree canopy. Because of their large size, they usually provide valuable wildlife tree habitat for many decades.
<b><i>wildlife tree</i></b>	A standing dead or live tree with special characteristics that provide valuable habitat for the conservation or enhancement of wildlife.

**Wildlife Dangerous Tree Committee** A committee organized in 1985 to find ways of maintaining wildlife tree habitat in timber harvesting and silviculture operations, without endangering the safety of forest workers.

**workplace** Includes all locations where a worker is or is likely to be engaged in work activities.

## APPENDICES



## APPENDIX 1. Some Important Tree Pathogens in B.C. Forests

Although there are thousands of different types of fungi present in the forest, only some cause decay. Of these, only a few are significant with respect to the development of wildlife trees. The most prevalent decay fungi relative to wildlife trees in British Columbia are listed below, alphabetically by disease name. Maps are also provided, showing the distribution of many of these species, as well as the distribution of core insect pathogens.

### Major Stem Diseases - Mainly Conifers

Disease name:	<b>Brown Crumbly Rot</b>
Organism name:	<i>Fomitopsis pinicola</i>
Common name of organism:	Red Belt Fungus
Hosts:	Many coniferous and deciduous species.
Characteristics useful for identification:	Perennial fruiting bodies hoof-shaped or shelved, brown-black with a red-brown margin. Pore surface white-cream.
Disease name:	<b>Brown Cubical Butt and Pocket Rot of Cedar</b>
Organism name:	<i>Postia sericeomollis</i>
Hosts:	Most conifers, most importantly western redcedar.
Characteristics useful for identification:	No reliable external indicators, fruiting bodies are thin and crust-like but very rare. Use an increment borer to check for decay.
Disease name:	<b>Brown Cubical Butt Rot</b>
Organism name:	<i>Phaeolus schweinitzii</i>
Common name of organism:	Velvet Top Fungus
Hosts:	Most conifers.
Characteristics useful for identification:	Stalked, annual fruiting bodies with brown, velvety tops that are up to 20 cm in diameter are found near the base of infected trees. In advanced decay the wood breaks into large red-brown cubes.
Disease name:	<b>Brown Cubical Rot</b>
Organism name:	<i>Laetiporus conifericola (sulphureus)</i>
Common name of organism:	Sulphur Fungus
Hosts:	Many coniferous and deciduous hosts.
Characteristics useful for identification:	Annual bracket-like fruiting bodies, bright yellow-orange in colour.

Disease name: **White Trunk Rot of Conifers**  
Organism name: *Phellinus hartigii*  
Common name of organism: Velvet fungus  
Hosts: Western hemlock, amabilis and subalpine fir, Douglas-fir.  
Characteristics useful for identification: Perennial, velvet fruiting bodies; hoof-shaped on stems, commonly along the underside of branches.

Disease name: **Brown Stringy Trunk Rot**  
Organism name: *Echinodontium tinctorium*  
Common name of organism: Indian paint fungus  
Hosts: Most importantly Hw and true firs, also other conifers.  
Characteristics useful for identification: Distinctive perennial fruiting bodies with tooth-like pore layer, usually associated with branch stubs.

Disease name: **Brown Trunk Rot**  
Organism name: *Laricifomes officinalis* (formerly *Fomitopsis officinalis*)  
Common name of organism: Quinine Fungus  
Hosts: Most commonly Lw, also on most other conifers.  
Characteristics useful for identification: Hard, perennial fruiting bodies, hoof-shaped to long and pendulous. Thick, white mycelial felts often associated with advanced decay.

Disease name: **Red Ring Rot**  
Organism name: *Porodaedalea pini* (formerly *Phellinus pini*)  
Hosts: Most conifers.  
Characteristics useful for identification: Hard, brown, perennial fruiting bodies, generally bracket-like, are associated with branch stubs. Decayed wood is red stained, distinctive white pockets.

### Major Stem Diseases - Mainly Hardwoods

Disease name: **Aspen Trunk Rot**  
Organism name: *Phellinus tremulae* ("Black conk")  
Hosts: Only on aspen.  
Characteristics useful for identification: Perennial fruiting bodies are hard, woody and triangular-shaped. Upper surface is gray-black and rough. The lower surface is brown.

Disease name: **Hardwood Trunk Rot**  
Organism name: *Phellinus igniarius*  
Hosts: Many deciduous tree species.  
Characteristics useful for identification: Perennial fruiting bodies are hard, woody and hoof shaped. The upper surface is gray-black and rough. The lower surface is brown, generally at a 90° angle to the stem.

Disease name: **White Mottled Rot**  
Organism name: *Ganoderma applanatum*  
Common name of organism: Varnish conk  
Hosts: Most hardwoods.  
Characteristics useful for identification: Perennial fruiting bodies are hard, leathery, flat and plate-like. The upper surface is brown. The lower surface is white, turning brown when bruised or marked.

Disease name: **White Spongy Trunk Rot**  
Organism name: *Fomes fomentarius*  
Hosts: Mainly birch, also other hardwoods.  
Characteristics useful for identification: Perennial fruiting bodies are hard, grey-brown and hoof-shaped. The pore layer is generally at a 90° angle to the stem.

Disease name: **Brittle Cinder butt rot**  
Organism name: *Kretzschmaria deusta*  
Hosts: Maple, Oak and Beech.  
Characteristics useful for identification: It is a soft rot, breaking down both the cellulose & lignin as it decays the trunk and/or roots of living trees. The fruiting body is a white mat at the base of the infected tree, then turns black as it matures; resembles black tar. Infected wood is brittle.



## Major Root Diseases

Disease name:	<b>Annosus Root and Butt Rot</b>
Organism name:	<i>Heterobasidion occidentale</i> (formerly <i>H. annosum</i> )
Hosts:	Many coniferous and deciduous species. In B.C., mainly Hw.
Characteristics useful for identification:	Fruiting bodies are rare, but when present will be found on the underside of stems and roots of windthrown trees. Wood in advanced state of decay is white and stringy with black flecks running parallel to the grain
Disease name:	<b>Black Stain Root Disease</b>
Organism name:	<i>Leptographium wageneri</i>
Hosts:	Mainly Fd, Pl, also Pw, Se, Sw, and Hw.
Characteristics useful for identification:	Reduced leader and branch growth, discoloured foliage. A purple-black stain is present in portions of annual rings in roots and up into the stem.
Disease name:	<b>Armillaria Root Rot</b>
Organism name:	<i>Armillaria solidipes</i> (formerly <i>A. ostoyae</i> )
Hosts:	Attacks all tree species; cedars and white pin tend to be more resistant.
Characteristics useful for identification:	Causes diagnostic crown symptoms (reduced leader growth, foliage discoloration & thinning). Resin may exude from bark on lower bole. Whitish mycelial fans may be seen under the bark. Fruiting bodies (mushrooms) occur around the base of infected trees and stumps. They are cream- to brown-coloured fleshy mushroom. Dead and diseased trees usually occur in disease centres (clusters).
Disease name:	<b>Laminated Root Rot</b>
Organism name:	<i>Phellinus sulphurascens</i> (formerly <i>P. weirii</i> )
Hosts:	Fd, Sx, hemlocks and true firs; a separate "form" occurs as a butt rot on Cw.
Characteristics useful for identification:	Infected trees often grouped in "disease centres." Standing infected trees have thinning, yellow foliage with reduced leader growth. Look for windthrown trees with "root balls" (lateral roots have characteristic laminated decay and are broken fairly close to stems).

Disease name:	<b>Tomentosus Root Rot</b>
Organism name:	<i>Inonotus tomentosus</i>
Hosts:	Mainly Spruce, also other conifers.
Characteristics useful for identification:	Stalked fruiting bodies, $\pm$ 10 cm in diameter, with velvety upper surface on ground near infected trees. Small longitudinal pits in decayed wood give it a honeycombed appearance.

Most of the preceding fungi have unique 'conks' or fruiting bodies that, with some practice, can be easily recognized and identified. However, fruiting bodies are not always present and visible. These conks occur on the bole or trunk of the tree and their presence, size, and frequency of occurrence can be good indicators of the amount of decay present in the host tree. Identifying the various types of conks and their associated fungi helps in identification and classification of both present and potential wildlife trees.

For example, a live tree infected with *Porodaedalea pini* with one conk present would likely be a very good wildlife tree and could be expected to persist for several years. On the other hand, a dead tree infected with one *Fomitopsis pinicola* conk would likely be a poor wildlife tree because it would probably have extensive decay and would not remain standing for long. Depending on its location, it could be a hazardous wildlife tree and would most likely not be worth saving.



*Ganoderma applanatum*

*Laetiporus conifericola*



## Root Disease

Root diseases are caused by fungi that kill the living parts and decay the woody parts of tree roots. Decay in the root system can advance several metres up the trunk. All root diseases produce similar symptoms—thin, yellowish (chlorotic) foliage, reduced growth, and distress cone crops (cones that are smaller than normal but perhaps more numerous). The severity of the symptoms depends on the disease organism, the species and size of the tree, and the proportion of the root system affected. Root disease fungi will eventually weaken the host tree, making it susceptible to bark beetles and saprophytic decay fungi. Root systems weakened by disease can make trees unstable.

## Cankers and Rusts

Fungi that cause cankers (an area of dead tissue marked by a flattened surface on the trunk) and rusts are two types of pathogens that can eventually girdle trees. The mortality rate depends on the species of fungus and the size of the host: small diameter trees are killed more easily. If no root pathogens or decay are present, the roots are generally stable. Aspen, poplars, lodgepole pine and white pine are the species most susceptible to stem or bark diseases. Pines attacked by stem rusts attract squirrels which chew the margins of the infections, resulting in resin flow.

## Heart Rots

Heart rot fungi may enter a tree through branch stubs, branchlet scars, or other wounds. As heartwood decays it becomes more easily excavated by primary cavity excavators. The sapwood remains intact, leaving a hard outer shell that protects nest cavities. The most common heart rot fungi are *Porodaedalea pini* (red ring rot) and *Fomitopsis pinicola* (brown crumbly rot) affecting many conifer species, *Echinodontium tinctorium* (Indian paint fungus) affecting hemlock and true firs, and *Phellinus tremulae* that affects aspen.

Living trees with heart rot are not prone to windthrow because the fungus does not usually attack the roots. Trees displaying several conks (fruiting bodies) are usually extensively decayed and are susceptible to breakage. However, the proliferation of fruiting bodies varies within the fungus. A lack of visible conks does not indicate a lack of heart rot.



*Porodaedalea pini*



*Echinodontium tinctorium*



*Phellinus tremulae*

## **Wound Decays**

Wound decay fungi are specialized fungi that invade freshly scarred trees where there is localized killing of tissue. Basal scars will often be colonized by wound decay fungi, and over time will result in a hollow at the tree's base. Some wound decay fungi are able to progress beyond the wound site and cause heart or sap rot, but they usually do not kill the tree.

Scars, broken tops, frost cracks, forks and crooks are decay indicators because they mark exposed sapwood that can serve as an entry point for decay fungi. Decay indicators are generally more reliable in conifers than in hardwoods. Decayed trees are prone to breakage, particularly at the site of infection and colonization. The larger or older the wound, the more susceptible to breakage the tree is likely to be.

## **Saprophytes**

Strict saprophytes, which can only colonize dead wood, cause decay in fallen logs and standing dead trees. Such fungi usually follow other organisms in the successional pathway and are effective competitors for woody substrates. Trees killed by repeated attacks by defoliators or bark beetles are susceptible to wood borers, secondary bark beetles (those that infest only severely stressed or dead trees), and saprophytic fungi. Decay by saprophytic fungi usually results in a soft outer shell, and decayed trees are prone to losing tops or large branches in wind or when subject to ground vibration. Whether there is more external decay (sap rot) or internal decay (heart rot) depends on what types of fungi become established and where the infection starts. For example, a tree that has a broken top before or shortly after death is more likely to be infected with heart rot than is a tree that remains intact. Dead trees continue to be decayed by saprophytes until they finally collapse.

## Witches' Brooms

Dwarf mistletoes are parasitic plants that absorb mineral nutrients, water and carbohydrates from the host. Their presence is marked by witches' brooms and sometimes by swollen cankers on branches or the main stem. Western hemlock, larch, lodgepole pine and Douglas-fir mistletoe produce large, heavy brooms. Although dwarf mistletoes are not usually the primary cause of tree death, they often make host trees more vulnerable to other pathogens. Needle-cast fungi and some species of rust fungi also cause brooming symptoms. Witches' brooms may provide an entry point for decay fungi and may reduce the vigor of host trees. Large brooms and infected branches are prone to breakage.

Large brooms may provide habitat for some species of wildlife. The brooms provide excellent shelter, hiding cover from predators, and good nesting sites. Several research studies have shown that the numbers and varieties of bird species present in stands that were heavily infected by dwarf mistletoe were significantly higher than in uninfected stands.

Several species of mammals, including flying squirrels, marten and fisher, also use brooms. One research study showed that fisher often sleep in dead or live brooms caused by spruce broom rust. (For breeding, fisher prefer to nest in old centre-rotted Douglas-firs, spruce or cottonwoods).

On the other hand, mistletoe is responsible for significant levels of mortality and growth reduction in managed forests. Live trees (Class 2) with mistletoe brooms within 20 metres of regenerating commercial forest trees should be carefully managed.

Death and decay are dynamic processes, but they do not necessarily occur rapidly. Trees may take decades to die and even longer to become decayed enough to be useful to some species of wildlife. Pathogens and trees in various stages of death and decay are important natural components of forest ecosystems.

## The Process of Tree Decay

Tree decay is a complex process, about which we still have a lot to learn. While there are several theories concerning decay and its various stages, the scenario outlined below is presented as a reasonable case for what the process could be like.

### Stages of Tree Decay

1. The host tree is wounded, with the wound providing a weakened area and hence a suitable infection site for an invading pathogen. The wound might be a broken branch stub, a broken top, a frost crack, or other area on the butt or bole of the tree where the bark has been removed.
2. The exposed wood becomes infected through the successful attack and subsequent establishment of a pathogen. Once established, the pathogen develops microscopic hyphal threads that penetrate between the cell walls of the wood. These threads secrete enzymes that condition and weaken the wood for further hyphal development. As the wood and cell walls weaken and the hyphae continue to grow, they invade the cells and obtain even more nutrients from them.
3. After the pathogen has become well established, a brown, reddish-brown or black stain may appear in the wood. This stain further conditions the wood for subsequent growth and development of the pathogen; in advanced stages it is often a diagnostic tool in identifying the disease. In fact, the common names of some decay fungi are derived from the distinctive color and pattern of stain they impart to the wood.
4. After several years, some triggering mechanism occurs and fungal hyphae, which may now form felts, fans or strands within the wood of the tree, produce fruiting bodies or 'conks' which grow on the branch, branch stubs or on the bole of the tree. Most of the conks associated with the pathogens listed in Table 1 are perennial, persisting for many years and often growing very large. The more numerous the conks and the larger their size, the more decay one can expect to find in the tree. Each conk and associated decay is different. Conks of some decay fungi (e.g., *Fomitopsis cajanderi*) may mean only a little rot is present. The presence of others (e.g., *Fomitopsis pinicola*) means that the host tree is likely already dead.
5. In the advanced stages of decay, the pathogen that originally killed the host tree may fade out, while a secondary pathogen becomes established, overtaking and displacing the primary pathogen.

## Common Pathogens of Trees in British Columbia

	Common/scientific name	Hosts	Notes
<b>REGION: North Coast</b> —Bella Coola is the approximate southern limit			
Diseases			
Stem diseases	Brown Stringy Trunk Rot <i>Echinodontium tinctorium</i>	Mountain and western hemlock; amabilis, grand and subalpine fir; white and Sitka spruce, Douglas-fir and western redcedar	High elevations only on coast, Not found on Queen Charlottes
	Red Ring Rot <i>Porodaedalea pini</i>	Mountain and western hemlock; amabilis, grand and subalpine fir; black, white, Engelmann and Sitka spruce; jack, lodgepole, ponderosa and western white pine; Douglas-fir, yellow-cedar, larch and western redcedar	Throughout the host range
	Brown Crumbly Rot <i>Fomitopsis pinicola</i>	Occurs on a wide range of hosts, including most conifers. It has not been reported on yellow-cedar, black spruce or maple in B.C. Red alder, paper birch, aspen and cottonwood	Is one of the most frequently occurring decay fungi in B.C. Is very common on dead trees but can cause considerable damage to live trees
	Hemlock Dwarf Mistletoe <i>Arceuthobium tsugense</i>	Hemlock	Throughout the host range
Root diseases	Annosus Root Rot <i>Heterobasidium occidentale</i>	Occurs on a wide variety of coniferous and broad-leaved species: western hemlock, amabilis and grand fir, white and Sitka spruce, lodgepole pine, Douglas-fir, western redcedar, bigleaf maple, and alder	Affects trees west of the coast mountains
	Tomentosus Root Rot <i>Inonotus tomentosus</i>	Sitka and white spruce	Mainly in ICH (Interior Cedar Hemlock) zone
Insects			
Bark beetles	Western Balsam Bark Beetle <i>Dryocoetes confusus</i>	Subalpine fir	Throughout the host range
Defoliators	Tent Caterpillar <i>Malacosoma disstria</i>	Trembling aspen	Throughout the host range
	Western Blackheaded Budworm <i>Acleris gloverana</i>	Western hemlock, amabilis fir, Sitka spruce	Throughout the host range
	Green Striped Forest Looper <i>Melanolophia imitheia</i>	Western hemlock	Throughout host range

Common/scientific name	Hosts	Notes
<b>REGION: South Coast</b> —Bella Coola is the approximate northern limit		
Diseases		
Stem diseases		
Brown Stringy Trunk Rot <i>Echinodontium tinctorium</i>	Mountain and western hemlock; amabilis, grand and subalpine fir; white and Sitka spruce; Douglas-fir and western redcedar	High elevations only on coast
Red Ring Rot <i>Porodaedalea pini</i>	Mountain and western hemlock; amabilis, grand and subalpine fir; black, white, Engelmann and Sitka spruce; jack, lodgepole, ponderosa and western white pine; Douglas-fir, yellow-cedar, larch and western redcedar	Throughout the host range
Aspen Trunk Rot <i>Phellinus tremulae</i>	Only on trembling aspen	Found where trembling aspen occurs on the south coast
Brown Crumbly Rot <i>Fomitopsis pinicola</i>	Occurs on a wide range of hosts, including most conifers; has not been reported on yellow-cedar, black spruce or maple in B.C. Red alder, paper birch, aspen and cottonwood	Is one of the most frequently occurring decay fungi in B.C. Is very common on dead trees but can cause considerable damage to live trees
Hemlock dwarf mistletoe <i>Arceuthobium tsugense</i>	Hemlock	Throughout the host range
Root diseases		
Armillaria Root Rot <i>Armillaria solidipes</i>	All native conifer species are susceptible except mountain hemlock	Throughout the host range south of 57° latitude
Annosus Root Rot <i>Heterobasidion occidentale</i>	Occurs on a wide variety of coniferous and broad-leaved species: western hemlock, amabilis and grand fir, white and Sitka spruce, lodgepole pine, Douglas-fir, western redcedar, bigleaf maple, and alder	Affects trees west of the coast mountains
Laminated Root Rot <i>Phellinus sulphurascens</i>	Douglas-fir; grand, Pacific silver and white firs; mountain hemlock	Throughout the host range, but most damaging to Douglas-fir in coastal stands
Blackstain root disease <i>Leptographium wageneri</i>	Douglas-fir	Throughout the host range
Insects		
Bark beetles		
Douglas-fir Beetle <i>Dendroctonus pseudotsugae</i>	Douglas-fir	Mainly eastern Vancouver Island and lower mainland north to host range
Defoliators		
Western Hemlock Looper <i>Lambdina fuscicollis lugubrosa</i>	Western hemlock	Occurs primarily south of latitude 56° along the coast
Western Blackheaded Budworm <i>Acleris gloverana</i>	Western hemlock; amabilis fir; Sitka spruce	Throughout the host range along the south coast
Western Spruce Budworm <i>Choristoneura occidentalis</i>	Douglas-fir; true firs; spruce	Throughout the host range along the south coast



	Common/scientific name	Hosts	Notes
<b>REGION: North and Central Interior</b> —from approximately Williams Lake and north			
Diseases			
Stem diseases	Brown Stringy Trunk Rot <i>Echinodontium tinctorium</i>	Mountain and western hemlock; amabilis, grand and subalpine fir; white and Sitka spruce; Douglas-fir and western redcedar	Main cause of heart rot in mature hemlock and true firs
	Red Ring Rot <i>Porodaedalea pini</i>	Mountain and western hemlock; amabilis, grand and subalpine fir; black, white, Engelmann and Sitka spruce; jack, lodgepole, ponderosa and western white pine; Douglas-fir, yellow-cedar, larch and western redcedar	Throughout the host range
	Aspen Trunk Rot <i>Phellinus tremulae</i>	Only on trembling aspen	Found where trembling aspen occurs
	White Spongy Trunk Rot <i>Fomes fomentarius</i>	White birch	Throughout host range
	Lodgepole Pine Dwarf Mistletoe <i>Arceuthobium americanum</i>	Lodgepole pine	Throughout host range
Root diseases	Tomentosus Root Rot <i>Inonotus tomentosus</i>	Amabilis and subalpine fir; Engelmann, black and white spruce; lodgepole, ponderosa and white bark pine; Douglas-fir; western hemlock; larch	Found in spruce-pine forests, particularly spruce stands in northern interior
Insects			
Bark beetles	Mountain Pine Beetle <i>Dendroctonus ponderosae</i>	All pines, especially lodgepole	Throughout the host range
	Spruce Beetle <i>Dendroctonus rufipennis</i>	Engelmann, white and Sitka spruce	Throughout the host range
	Western Balsam Bark Beetle <i>Dryocoetes confusus</i>	Subalpine fir	Throughout the host range, on the east of the coast mountains
Defoliators	Forest Tent Caterpillar <i>Malacosoma disstria</i>	Trembling aspen	Throughout the host range
	Large Aspen Tortrix <i>Choristoneura conflictana</i>	Trembling aspen	Throughout host range
	2-year Cycle Budworm <i>Choristoneura biennis</i>	White spruce; subalpine fir	Sub-boreal spruce zone McBride, Hazelton and North
	Western Blackheaded Budworm <i>Acleris gloverana</i>	Subalpine fir; white spruce	Throughout the host range
	Eastern Spruce Budworm <i>Choristoneura fumiferana</i>	Subalpine fir; white spruce	Fort Nelson area

Common/scientific name	Hosts	Notes	
<b>REGION: South Interior</b> —from approximately Williams Lake and south			
Diseases			
Stem diseases	Brown Stringy Trunk Rot <i>Echinodontium tinctorium</i>	Mountain and western hemlock; grand and subalpine fir; white spruce; Douglas-fir; western redcedar	Interior wet belt. Main cause of heart rot in mature hemlock and true firs
	Red Ring Rot <i>Porodaedalea pini</i>	Mountain and western hemlock; grand and subalpine fir; black, white, Engelmann and Sitka spruce; jack, lodgepole, ponderosa and western white pine; Douglas-fir; larch; western redcedar	Throughout the host range
	Lodgepole Pine Dwarf Mistletoe <i>Arceuthobium americanum</i>	Lodgepole pine	Throughout host range
	Aspen Trunk Rot <i>Phellinus tremulae</i>	Only on trembling aspen	Found where trembling aspen occurs
	Brown Crumbly Rot <i>Fomitopsis pinicola</i>	Occurs on a wide range of hosts, including most conifers; has not been reported on yellow-cedar, black spruce or maple in B.C. Red alder; paper birch; aspen; cottonwood	One of the most frequently occurring decay fungi in B.C. Very common on dead trees but can cause considerable damage to live trees occurs
	White Spongy Trunk Rot <i>Fomes fomentarius</i>	White birch	Throughout host range
Root diseases	Armillaria Root Rot <i>Armillaria solidipes</i>	All native conifer species are susceptible except mountain hemlock	Most prevalent in south interior
	Tomentosus Root Rot <i>Inonotus tomentosus</i>	Amabilis and subalpine fir; Engelmann, black and white spruce; lodgepole, ponderosa and white bark pine; Douglas-fir, western hemlock; larch	Less common than in north interior. Usually in moist spruce stands at high elevations
	Laminated Root Rot <i>Phellinus sulphurascens</i>	Douglas-fir; grand fir; western hemlock	Rare, east of Purcell mountains
	Blackstain root disease <i>Leptographium wageneri</i>	Douglas-fir	Primarily West Kootenays
Insects			
Bark beetles	Mountain Pine Beetle <i>Dendroctonus ponderosae</i>	All pines, especially lodgepole	Throughout the host range
	Spruce Beetle <i>Dendroctonus rufipennis</i>	Engelmann and white spruce	Throughout the host range
	Western Balsam Bark Beetle <i>Dryocoetes confuses</i>	Subalpine fir	Throughout the host range
Defoliators	2-year Cycle Budworm <i>Christoneura biennis</i>	Engelmann spruce; subalpine fir	High elevation in SE B.C.
	Forest Tent Caterpillar <i>Malacosoma disstria</i>	Trembling aspen	Throughout the host range
	Western Hemlock Looper <i>Lambdina fiscellaria lugubrosa</i>	Western hemlock	Primarily in the interior wet belt
	Western Spruce Budworm <i>Christoneura occidentalis</i>	Douglas-fir; true firs; spruce	Okanagan and West Kootenays
	Douglas-fir Tussock Moth <i>Orgyia pseudotsugata</i>	Douglas-fir	Throughout Okanagan and drier areas of West Kootenays

**APPENDIX 2.** Users of Wildlife Trees and Level Of Dependency

Dependency	Use
1 High	R Reproduction
2 Common	F Feeding
3 Occasional	S Shelter
	^ Artificial

**Key**

SCU	Secondary cavity user
PCE	Primary cavity excavator
1R	Highly dependent on wildlife trees for reproduction
1R^	Highly dependent on wildlife trees for reproduction, but may use artificial structures when available
IF	Highly dependent on wildlife trees for feeding
1S	Highly dependent on wildlife trees for other needs, such as shelter
1S^	Highly dependent on wildlife trees for other needs, such as shelter, but may use artificial structures when available
2R	Commonly uses wildlife trees for reproduction, but also uses alternative natural sites and/or artificial structures (moderately dependent)
2F	Commonly uses wildlife trees for feeding (moderately dependent)
2S	Commonly uses wildlife trees for other needs, such as shelter (moderately dependent)
3R	Occasionally uses wildlife trees for reproduction (non-dependent)
3S	Occasionally uses wildlife trees for other needs, such as shelter (non-dependent)

**NOTE:** Cavities used by any of the species may be natural cavities or vacated woodpecker holes.

Species	Wildlife Tree Users	Dependency Level
<b>Amphibians</b>		
Clouded salamander	lays eggs in rotting wood; feeding site; shelter	2RFS
<b>Aquatic Birds</b>		
Great Blue Heron	open nest on large tree limbs	2R
Wood Duck	Secondary Cavity User (SCU)	1R^
Barrow's Goldeneye	SCU	1R^
Common Goldeneye	SCU	1R^
Bufflehead	SCU	1R^
Common Merganser	SCU	2R
Hooded Merganser	SCU	1R^
Marbled Murrelet	SCU (old growth/coniferous, if large live trees are wildlife trees)	2R
<b>Birds of Prey</b>		
Bald Eagle	open nest on large tree limbs; hunting perch; roost	2RS
Cooper's Hawk	open nest in live trees, in crotch near main trunk	3R
Northern Goshawk	hunting perch; nest in largest tree in the stand line	3R
Red-tailed Hawk	hunting perch; nest in large trees, often dead tops	2R
Osprey	open nest on large tree stump and limbs; lookout & feeding perch	1R^2FS
American Kestrel	SCU; hunting perch	1R^3F
Great Horned Owl	SCU; nest in broken treetop; hunting perch	2RF
Barred Owl	SCU; nest in broken treetop and large limbs; winter roost	1R2S
Spotted Owl	SCU; winter roost (cavity)	1R
Western Screech-Owl	SCU; winter roost (cavity)	1R^2S
Flammulated Owl	SCU	1RS
Northern Pygmy-Owl	SCU; winter roost	1R2S
Northern Saw-whet Owl	SCU; winter roost	1R2S
Northern Hawk Owl	SCU; nest in broken treetop; hunting perch; winter roost (cavity)	2RFS
Boreal Owl	SCU; winter roost	1R2S

Species	Wildlife Tree Users	Dependency Level
<b>Woodpeckers</b>		
Lewis' Woodpecker	Primary Cavity Excavator (PCE) & roost – soft wood; hawking perch; foraging	1RS2F
Yellow-bellied Sapsucker	PCE & roost – live trees, sound and soft wood; foraging	1RS
Red-naped Sapsucker	PCE & roost – live trees, sound and soft wood; foraging	1RS
Red-breasted Sapsucker	PCE & roost – live trees, sound and soft wood; foraging	1RS
Williamson's Sapsucker	PCE & roost – sound wood; foraging	1RS
Downy Woodpecker	PCE & roost – soft wood; foraging	1RS
Hairy Woodpecker	PCE & roost – sound or soft wood; foraging	1RS2F
White-headed Woodpecker	PCE & roost – sound or soft wood; foraging	1RS2F
Three-toed Woodpecker	PCE & roost – sound or soft wood; foraging	1RFS
Black-backed Woodpecker	PCE & roost – sound or soft wood; foraging	1RFS
Northern Flicker	PCE & roost – soft wood; foraging	1RS
Pileated Woodpecker	PCE & roost – sound wood; foraging	1RFS
<b>Insectivorous perching birds</b>		
Vaux's Swift	SCU	1R1S
Tree Swallow	SCU	1R^3S
Violet-green Swallow	SCU	2R^3S
Black-capped Chickadee	PCE – soft wood; opportunistic SCU; foraging; winter roost (cavity)	1R^S
Mountain Chickadee	PCE – soft wood; opportunistic SCU; foraging; winter roost (cavity)	1R^S
Boreal Chickadee	PCE – soft wood; opportunistic SCU; foraging; winter roost (cavity)	1RS
Chestnut-backed Chickadee	PCE – soft wood; opportunistic SCU; foraging; winter roost (cavity)	1R^S
Red-breasted Nuthatch	PCE – soft wood; occasional SCU; foraging; winter roost (cavity)	1RS
White-breasted Nuthatch	PCE – soft wood; opportunistic SCU; foraging; winter roost (cavity)	1R^S
Pygmy Nuthatch	PCE – soft wood; opportunistic SCU; foraging; winter roost (cavity)	1R^S
Brown Creeper	SCU (behind bark); foraging	1RS
Western Bluebird	SCU; hawking perch	1R^
Mountain Bluebird	SCU; hawking perch	1R^

Species	Wildlife Tree Users	Dependency Level
<b>Bats</b>		
California Myotis	nursery/day roost in cavities and behind bark	2RS
Western Long-eared Myotis	nursery and day roost in cavities and behind bark	2RS
Keen's Long-eared Myotis	nursery and day roost in cavities and behind bark	2RS
Little Brown Myotis	nursery and day roost in cavities and behind bark	3RS
Northern Long-eared Myotis	nursery and day roost behind bark	2RS
Long-legged Myotis	nursery and day roost in cavities and behind bark	2RS
Yuma Myotis	nursery and day roost in cavities and behind bark	2RS
Hoary Bat	day roost in cavities	3S
Silver-haired Bat	nursery, day roost, and hibernation site in cavities and behind bark	1RS
Big Brown Bat	nursery and day roost in cavities	3R2S
Townsend's Big-eared Bat	unknown	–
Pallid Bat	day roost in cavities	3S
<b>Rodents</b>		
Bushy-tailed Woodrat	nest, summer and winter dens in cavities	3RS
Keen's Mouse	nests in cavity or behind bark; summer and winter dens in cavities	2RS
Northern Flying Squirrel	nest, summer and winter dens in cavities; cavities used as feeding stations	1RS3F
Chipmunks	nest and summer den in cavities	3RS
Douglas' Squirrel	nest, summer and winter dens in cavities; cavities used as feeding stations	2RS/3F
Red Squirrel	nest, summer and winter dens in cavities; cavities used as feeding stations	2RS/3F
<b>Weasel Family</b>		
Marten	nest, summer and winter dens in cavities	2RS
Fisher	nest, summer and winter dens in cavities	1R 2S
Ermine	nest and summer den in cavities	3RS
<b>Other Mammals</b>		
Raccoon	nest, summer and winter dens in cavities	2RS
Black Bear	hibernates in hollow trees and standing dead trees	2RS
Caribou	feeds on arboreal lichens on old trees and standing dead trees	2F

## APPENDIX 3. Dangerous Tree Management in Preparation for Silviculture Activities

### *Wildlife Tree Committee of BC*

## Dangerous Tree Management in Preparation for Silviculture Activities

#### Background

The standard of care for the management of dangerous trees (DT) in forestry operations of British Columbia is outlined in the Wildlife/Danger Tree Assessors Course (WDTAC). The WDTAC is endorsed by WorkSafeBC (the Workers' Compensation Board of BC) and was developed to promote the conservation of wildlife trees and associated stand-level biodiversity in a safe and operationally efficient manner. The harvesting and silviculture module of the WDTAC details the specific assessment criteria and damage thresholds necessary to determine whether tree defects are safe or dangerous for given work activities, and recommends the appropriate safe work procedures.

The effects of wildfire and insect damage have recently impacted numerous sites throughout British Columbia. As resource managers prepare for the reforestation of these impacted sites it is of critical importance that planners and contractors carefully consider how potentially DT are going to be managed prior to the commencement of silviculture activities.

The Wildlife Tree Committee of BC (WTC) was asked by various stakeholders to clarify how DT should be managed, especially in situations where there are high densities of standing dead and dying trees. Members of the WTC participated in a field review of a number of sites in the Kamloops and Princeton areas. The following information outlines appropriate points of control that are needed to promote a safe and effective reforestation strategy.

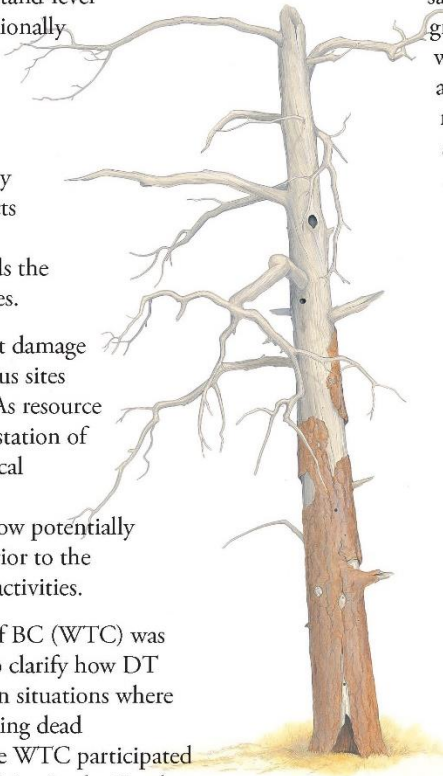

#### Points of Control for Worksite Safety

Foundational to effective and safe implementation of forestry projects are a clear understanding of the treatment objectives, the coordination of hazard planning, and the establishment of a safety management system. A framework for the process can be presented in a "points of control" matrix for worker safety. It is a linkage of all participant groups, from landowner to forestry worker, who are responsible for the activities at the worksite. Specific to reforestation of high stem density sites, a "points of control" matrix is outlined in table 1. This matrix links all the various groups to a set of control tasks that must be integrated and coordinated. The control tasks include the setting of management objectives, submitting a notice of project forestry to WorkSafeBC, assessing the capacity of workforce tiers (contractors, assessors, fallers, planters, equipment operators), assessment of worksite hazards, and opportunities for seeking consultation.

The process for mitigating the hazards associated with DT can seem overwhelming amidst a landscape of dead and dying trees. However, with a commitment to develop and follow a "points of control" process, managers can safely manage DT and implement successful silviculture projects.



### Dangerous Tree Assessment and Planning

Before planners select a mitigation plan for dangerous trees they must recognize the fact that hand falling is one of the most hazardous occupations in BC. To safely fall DT requires considerable training, experience and supervision. It is imperative that managers, supervisors, and fallers work together to reduce the risks associated with managing DT. This process will require a shift in the worker's mind set from "CAN the DT be felled?" (risk acceptance) to one of "SHOULD the DT be felled?" (risk control). Managers can help to minimize the amount of hand falling by implementing the following during the assessment and planning phase of reforestation projects:

1. Conduct a thorough site assessment to stratify the work site into treatment units of similar safety and operational needs (e.g., high/low density of dangerous trees, high/low levels of natural regeneration, high/low priority treatment areas, etc). Consideration should be given to the following stand and site factors:
  - a. Stand history and condition (disturbance history, time-since-death, age and density of the stand, tree species composition, etc),
  - b. Common weather patterns and conditions (snow, fog, ice, flooding, drought),
  - c. Windthrow potential,
  - d. Tree symptoms (crown thinning, basal resin flows, root disease, tree lean, conks, etc.), and
  - e. Tree failure patterns and causes;
2. Consider the acceptability of natural regeneration (usually abundant on burned areas) amidst multiple management objectives (access plans, fuel loading and abatement strategies, wildlife needs, recreation and visual quality objectives, future stand tending plans, forest health issues, etc);
3. Use experienced and qualified DT assessors that can assess to the proper assessment criteria for Level of Disturbance (LOD) 1. Inexperienced assessors may default trees into a dangerous rating because of insufficient knowledge and skill to correctly apply the LOD-1 hazard assessment criteria. It is also recommended that assessment be done as a separate phase and prior to treatment for some of the following reasons:
  - a. Combined faller-assessor roles can distract the faller from devoting their full concentration when falling DT,
  - b. The assessment phase provides time to develop or consider alternatives to hand falling (e.g. use of NWZ or modify treatment plans),
  - c. Faller-assessors tend to treat more trees than required because of the "if in doubt, cut it out" factor, and
  - d. Planners are better able to anticipate and control slash loading (excessive slash from over-treating can reduce mobility to planters and increases eye-level hazards for planters); and
4. Integrate the use of no-work zones to reduce the reliance on hand falling, or to consider alternatives to hand falling (machine assist, explosives, mechanized falling, land clearing with appropriately guarded equipment).

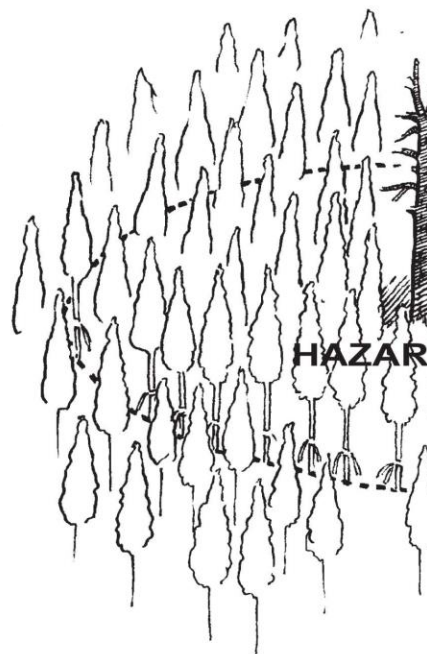

### Managing Dangerous Tree Mitigation

Once the decision is made to hand fall a DT it is imperative that management, supervisors and fallers have a clear understanding of how the LOD for each treatment phase is integrated into the safety plans. According to the WDTAC, the failure potential for tree defects varies in relation to the LOD. Tree planting is considered to be a LOD-1 activity while tree falling is a LOD-3 activity. A tree with defects dangerous for LOD-3 activities may be safe for LOD-1 activities. Therefore, the following safety controls



must be followed for hand falling a tree identified as dangerous for LOD-1 reforestation activities:

1. Use fallers that are qualified and certified to a standard acceptable to the Board and are experienced in falling dangerous trees for the timber type and terrain conditions of the site;
2. Provide supervision by a qualified person during the falling operation;
3. Ensure the faller assesses the immediate surroundings around the dangerous tree and

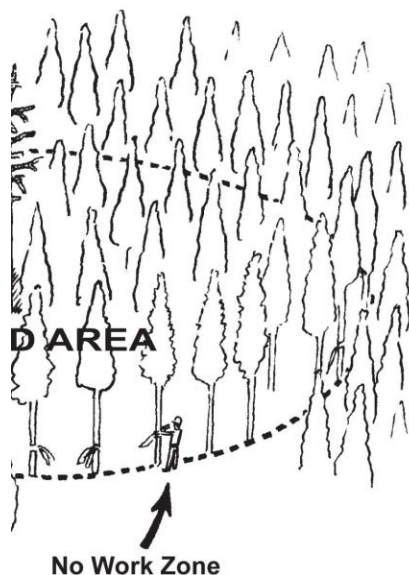

then removes any hazards that will prevent the safe felling of the identified dangerous tree. Some of the hazards the faller must consider include:

- a. Ground debris,
  - b. Overhead hazards and tree lean,
  - c. Compromised escape routes,
  - d. Loose rock, and
  - e. Presence of trees that are dangerous for the activity of falling (trees that meet the assessment criteria of dangerous for LOD-3);
4. Ensure the faller carefully determines a falling plan for each DT, giving consideration to the hazard area (a spherical area) surrounding the identified LOD-1 DT:
    - a. The hazard area around the DT will be defined by the size and density of surrounding trees but has traditionally been considered 1.5 tree lengths,
    - b. The faller must decide whether the identified DT can be felled safely into an opening without brushing other standing trees, and
    - c. The site treatment plan must provide the faller with flexibility to overcome falling difficulties (opportunity to create an adequate opening,

or remove trees within the hazard area that are rated as dangerous for LOD-3 and may put the faller at risk when attempting to fall the identified DT);

5. Ensure the treatment actions appropriately manage to the appropriate LOD:
  - a. The LOD for the hazard area of the identified DT is temporarily LOD-3. The falling plan for this DT must consider the presence of trees having dangerous defects according to LOD-3 criteria,
  - b. Once the faller has safely removed the identified LOD-1 DT the falling task is over within the hazard area of this DT and the faller moves to the next identified DT,
  - c. Fallers should not continue to “sanitize” the hazard area of trees that might be dangerous for LOD-3 (but Safe for LOD-1) simply because there was a momentary falling activity (i.e., the cutting of one dangerous tree),
  - d. If the density of identified LOD-1 DT are high and the hazard areas overlap continuously from DT to DT, then the treatment at the worksite must be upgraded to a LOD-3 treatment, and
  - e. In extremely high density stands where openings are few the faller must review trees within the hazard area according to the LOD-4 criteria and adjust the falling plan around each DT accordingly.

### Communication

It is important throughout the site management process that each participant group documents its activities and communicates in a timely manner to the participant groups identified in the safety management system (see the points of control matrix). Where uncertainty exists, these items need to be reviewed on-site and clarified before proceeding. Opportunities for continuous improvement can also be better realized if there is regular communication amongst the participant groups.

For further information on how to integrate DT management to your work plans consult with your local WorkSafeBC safety officer or contact the WTC at: [www.for.gov.bc.ca/hfp/values/wildlife/WLT/contacts.htm](http://www.for.gov.bc.ca/hfp/values/wildlife/WLT/contacts.htm).

Table 1: Danger tree assessment “points of control” for high-density stem count areas							
Group (s)	Management Objectives and Planning	Due Diligence Documentation	Assessment of Capacity	Hazard Management	No Work Zones (NWZ)	Access Route Hazards	Consultations
<b>Owner</b>	Does the area require planting? What are the treatment objectives? Strategy shift from “can it be done” to “should it be done”.	Signed contracts with emphasis on safety systems in place and working, meetings, site visits, Notice of Project-Forestry (NoPF), etc.	Is the PC capable of doing the job? (confirm past experience)	Pass on all known or ought to be known hazards to the next level.	Assessor’s role in a continuum of land use plans.	Pass on all known or ought to be known hazards to the next level.	With PC, Project Recipient, WorkSafeBC and/or Wildlife Tree Committee.
<b>Prime Contractor (PC)</b>	Treatment objectives, hazard planning, safety management system in place to ensure coordination of and compliance by sub-contractors.	Signed agreement acknowledging control for a specific time and area; NoPF; all meetings, site safety plan, site visits, etc..	Is the contractor capable of taking on the job functions? (confirm past experience).	Pass on all known or ought to be known hazards to the next level. Mitigate where responsible.	Assessor’s function is clearly communicated.	Access safety coordination, use proper road protocol, ensure access roads are safe to use. (Presence of DT, x-ditches, cut/fill slopes, etc).	With Owner, Project Recipient, WorkSafeBC and/or Wildlife Tree Committee.
<b>Project Recipient (contract or permit license holder)</b>	Planning for the project, resources, locations, work sequencing, etc. Meetings with supervisor and workers, pre-work orientations.	Signed contracts with emphasis on safety systems in place and working; meetings, site visits, NoPF, site safety plan, etc.	Are the supervisor and/or the faller/ operators and planters qualified and capable of doing the job?	Pass on all known or ought to be known hazards to the next level. Mitigate or eliminate known hazards.	Ensure Assessors are aware of expectations.	Ensure access roads are safe for travel, use proper road protocol (Presence of DT, x-ditches, cut/fill slopes, etc).	With Owner, PC, Supervisor, Assessor, Workers, WorkSafeBC and/or Wildlife Tree Committee.
<b>Supervisor</b>	Daily for the project, resources, locations, work sequencing, etc. Meetings with workers (pre-work orientations, crew talks, etc.).	Safety meetings (initial and on-going) with all crews, site inspections, incident investigations, site safety plan, daily safety contacts.	Are assessors and fallers qualified and able to perform their job functions? Site inspections conducted?	Pass on all known or ought to be known hazards to the next level. Mitigate or eliminate known hazards.	Ensure Assessors are aware of expectations.	Report hazards on access roads to all and use proper road protocol.	With PC, Assessor, Workers, WorkSafeBC and/or Wildlife Tree Committee.
<b>Tree Assessor</b>	Site overview with treatment objectives, 5 step process from WDTAC.	Valid and current DT certification; Site Assessment Overview Summary; Assessment LOD and criteria; map and field marking procedures; assessment cards; mitigation and site safety plan.	Will the workers be able to conduct the work safely according to the assessments?	Pass on all known or ought to be known hazards to the next level.	Areas meeting the NWZ criteria will be identified appropriately. Should the faller try to fall or is a NWZ safest?	Report hazards on access roads to person in charge and use proper road protocol.	With Recipient, Supervisor, WorkSafeBC and/or Wildlife Tree Committee.
<b>Faller</b>	Qualified and certified fallers meet with Supervisor to review objectives (Possess the knowledge, skills, abilities and experience to fall DT) Are alternatives available (blasting, machine assist, etc).	Site safety plan; Valid and current DT Certification; Faller’s certification and logbook; record of DT mitigation and NWZ; Pre-work and tailgate reviews; Quality Assurance reviews; DT Blaster certificate and Blaster’s Log Book.	Each situation as it appears in the work plan and on the ground must consider all aspects of the BC faller standard.	Recognize, evaluate and control the hazards on-site.	Keep out of NWZ and/or when a situation is beyond ability; find assistance and report to person in charge.	Report hazards on access roads to person in charge and use proper road protocol. Use traffic control when falling near roads.	With Recipient, Supervisor, Assessor, WorkSafeBC and/or Wildlife Tree Committee.
<b>Machine Operators</b>	Qualified and Experienced Operators meet with Supervisor or recipient to review objectives. Does the treatment produce the desired results and within safety regulations?	Site safety plan; DT awareness training; safe work procedures; record of DT mitigation & NWZ; Prework and tailgate reviews. Quality Assurance reviews.	Each situation as it appears in the work plan and on the ground considering all aspects of: experience, slope restrictions, machine guarding, manufacturer’s written specifications, regulations, etc.	Recognize, evaluate and control the hazards on-site.	Keep out of NWZ and/or when a situation is beyond ability find assistance and report to person in charge.	Report hazards on access roads to person in charge and use proper road protocol. Use traffic control when tree may fall near roads.	With Recipient, Supervisor, Assessor, Workers, WorkSafeBC and/or Wildlife Tree Committee.
<b>Tree Planters</b>	Initial meeting with Supervisor or Recipient to review objectives. Can the treatment be safely implemented?	Site Safety plans (work restrictions, evacuation routes); QP training or DT certification; record of NWZ installations; Pre-work and tailgate safety reviews; safety inspections and incident reviews.	Each situation as it appears in the work plan and on the ground; consider escape routes and safety zones.	Recognize, evaluate and know when to evacuate due to hazards.	Keep out of NWZ and/or when a situation is beyond ability find assistance and report to person in charge.	Report hazards on access roads to person in charge and use proper road protocol.	With Recipient, Supervisor, Assessor, Workers, WorkSafeBC and/or Wildlife Tree Committee.

## APPENDIX 4. Pertinent Regulations

### Workers' Compensation Board Occupational Health and Safety Regulation

#### Part 26: Forestry Operations and Similar Activities

##### Section 1: Definitions

**Dangerous Tree:** Means a tree that is a hazard to a worker due to

- (a) its location or lean,
- (b) its physical damage,
- (c) overhead conditions,
- (d) deterioration of its limbs, stem or root system,
- (e) or any combination of the conditions in paragraphs (a) to (d).

##### Section 2: Planning and conducting a forestry operation

- (1) The owner of a forestry operation must ensure that all activities of the forestry operation are both planned and conducted in a manner consistent with this Regulation and with safe work practices acceptable to the Board.
- (2) Every person who has knowledge and control of any particular activity in a forestry operation must ensure that the activity is both planned and conducted in a manner consistent with this Regulation and with safe work practices acceptable to the Board.
- (3) The planning required under this section must
  - (a) Include the identification of any work activities or conditions at the workplace where there is a known or reasonably foreseeable risk to workers,
  - (b) To be completed before work commences on the relevant activity, and
  - (c) Be documented at the time of planning.
- (4) If, after any planning referred to in subsection (3), there is a change in the workplace circumstances, including the work activities and the conditions of the workplace, and the change poses or creates a known or reasonably foreseeable risk to workers that was not previously identified, then
  - (a) The plan must be amended to identify and address the risk and provide for the health and safety of the workers at the workplace, and
  - (b) The amendment must be documented as soon as is practicable.

## Section 11: Dangerous Trees

- (1) If it is known or reasonably foreseeable that work will expose a worker to a dangerous tree,
  - (a) the tree must be felled, or
  - (b) a risk assessment of the tree must be undertaken by a person who has completed a training program acceptable to the Board.
- (2) If a risk assessment under subsection (1) determines that a tree poses a risk to a worker, the recommendations made in the risk assessment for eliminating or minimizing the risk must be implemented before the work referred to in that subsection starts.
- (3) Despite subsections (1) and (2), if work in a forestry operation is to be carried out in an area that has more than 500 dangerous trees per hectare, the Board may approve a request to work without felling or assessing all the dangerous trees, if before the work starts,
  - (a) a person who has completed a training program acceptable to the Board conducts a risk assessment of a representative sample of the dangerous trees, and
  - (b) any recommendations made in the risk assessment for eliminating or minimizing the risks are implemented.

## Resource Management Ministry Policy Manual 8: Tenure administration—Fire- wood cutting: Free use permit: General Procedures—Wildlife Trees

### Wildlife Trees

Firewood collection areas should be inspected for the presence of wildlife trees. Any trees with a potential to serve as wildlife trees should be posted with the conspicuous square yellow sign.

A copy of the brochure “Firewood—or Wildlife Tree” should be given to each recipient of a free use permit for the collection of firewood.

The District Manager will explain the wildlife tree concept and ask that the applicant not cut or remove any trees that have been posted with wildlife tree signs.



## Wildlife Act

In British Columbia, Section 34 of the *Wildlife Act* concerns wildlife trees. It reads as follows:

**A person who, except as provided by regulation, possesses, takes, injures, molests or destroys**

**(a) a bird or its egg,**

**(b) the nest of an eagle, peregrine falcon, gyrfalcon, osprey, heron or burrowing owl, or**

**(c) the nest of a bird not referred to in paragraph (b) when the nest is occupied by a bird or its egg**

**commits an offense.**

*Osprey nests are protected  
under Section 34 of the Wildlife*

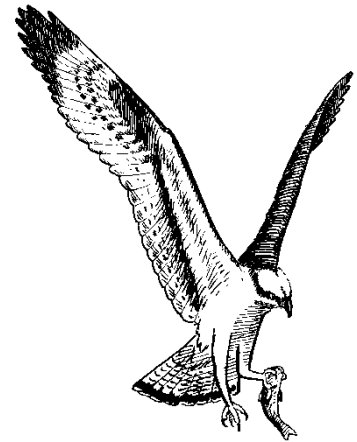

## Specified Tree Protection Regulation in BC

A specified tree is a standing tree (live or dead) of a specific species with a certain diameter at breast height (DBH) and in some cases located in a defined area of the Province (crown or private forest lands). There are eleven species identified in the regulation and a tree must meet or exceed the prescribed DBH to be recognized as a specified tree. These trees and their associated 1-hectare buffer of supporting trees are protected from primary forestry activities (timber harvesting, silviculture treatments, wildlife habitat enhancement, or road construction, maintenance and deactivation). The buffer has a horizontal distance (HD) radius of 56 meters with the specified tree at the centre. To remove or modify a specified tree requires an application and approval for an exemption; even if the tree is deemed to be a Dangerous Tree, an exemption approval is required.

## Heritage Conservation Act

CMT's and any archaeological site containing physical evidence of human use or habitation prior to 1846 is potentially subject to provisions of the prevailing legislation, the Heritage Conservation Act.

## **Guidebooks Containing Reference to Wildlife Trees**

Stand Management Prescription Guidebook

Forest Practices Code Guidebooks

- Biodiversity Guidebook
- Defoliator Management Guidebook
- Dwarf Mistletoe Management Guidebook
- Forest Development Plan Guidebook
- Forest Road Engineering Guidebook
- Green up Guidebook
- Lake Classification and Lakeshore Management Guidebook: Kamloops Forest
- Lake Classification and Lakeshore Management Guidebook: Nelson Forest
- Lake Classification and Lakeshore Management Guidebook: Prince George
- Logging Plan Guidebook
- Pruning Guidebook
- Riparian Management Area Guidebook
- Silviculture Prescription Guidebook
- Silviculture Surveys Guidebook
- Site Preparation Guidebook
- Spacing Guidebook

**See the WTC website for links to Ministry of Forests and Ministry of Environment and Climate Change Strategy policies and regulations which may be relevant to the management of wildlife trees.**

## APPENDIX 5. A Discussion of Liability and Dangerous Tree Assessment

“Duty of care” is the legal responsibility of the landowner or someone acting on their behalf (i.e., forest manager, park manager) to reasonably ensure the safety of persons working on or using that property. The duty of care is often established by various Acts or policies such as the *Occupiers Liability Act*. The Duty of Care invokes a certain standard of conduct called the “standard of care”. Standard of care is defined as the best available guidelines and practices used to fulfill a particular “duty of care”. Standard of care is recognized according to established procedures at an accepted level of standards. The Wildlife/Dangerous tree Assessment process and associated course (WDTAC) is recognized in B.C. as the current “standard of care” relative to the determination of tree danger and hazards.

Relative to persons who might be assessing trees for work activities or other situations, as long as these are qualified persons (i.e., they have successfully completed standardized training in dangerous tree assessment or have demonstrated knowledge and experience of the work activity and hazards involved) who have applied the accepted standard of care for dangerous tree assessment (i.e., the WDTAC process), and have done so with due diligence (i.e., they were not negligent in following the accepted procedures or techniques), then they should not be held liable if a subsequent accident were to happen relative to a previously assessed tree. The assessment by said person would be viewed as consistent with “what a reasonable and prudent person (i.e., trained with similar qualifications) would have concluded under similar circumstances.” Therefore, there would be no case for liability since **liability has to be proven, usually by showing that some sort of negligence was involved**. Generally, *liability hinges on whether or not there was a duty of care to be exercised, and if so, whether or not it was negligently implemented* (i.e., the accepted standard of care was not adhered to). In other words, was the person “**duly diligent**” in performing the work required?

“Due diligence” is the process of performing a task to the best of one’s knowledge, ability and, as far as reasonably possible, according to the prescribed procedures.

When determining whether “due diligence” was taken, the following will be considered:

- Who was involved? A combination of the following determine one’s capability for completing the particular task:
  - ~ knowledge
  - ~ training
  - ~ experience
  - ~ skills
  
- What was done.
  - ~ was the work done as well as others would do it? according to accepted procedures?
  - ~ what is required by regulation for the work done?





**APPENDIX 6.** Dangerous tree Assessment Field Data Forms - Site Assessment Overview Card

<b>Site Assessment Overview Summary</b>			Date (mm/dd/yyyy):
Location:	Tenure Holder:	Tenure:	
Stratum Identification:	Operation:	Assessor's Name:	
Forestry activity and LOD:	Planned start-up and end dates:		
Stratum conditions (Describe leave trees - species, sizes, condition, ages and density distribution):			
WT management objectives (Describe constraints to NWZ, WT retention):			
Stand Density and Site History	Site Hazards	Common Tree Pathogens/Cause of Failure (List factors and severity/frequency)	
Disturbance year	Bluffs/cliffs/sink holes		
Disturbance type	Gorges/streams/gullies		
Recent tree failure(s)	Rock talus/scree		
Past tree failure(s)	Steep/unstable terrain		
Fire intensity (L, M, H)	Recent edge/tree exposures		
Tree retention pattern - even clumps irregular	Snow/ice/fog		
Retention tree density (L, M, H)	Windthrow risk		
Tree species mix	Shallow/saturated soils		
Tree age (dom/co-dom)	Stand decadence		
Prevailing wind direction	Other:		
Wildlife tree use (L, M, H)			
Mitigation Strategies	Constraints	Communication	
Falling/machine clearing/blasting	Wind speed criteria	Evacuation routes	
NWZ criteria	Weather	Refuge area	
Tree modification	Seasonal issues	Road use control	



Appendix 6. DANGEROUS TREE ASSESSMENT FIELD DATA FORMS  
 TREE ASSESSMENT DATA CARD – SAMPLE

DANGER TREE ASSESSMENT FIELD DATA															Assessor's Name:		Date:																
District:			Location: Demlin Main			Licensee: ABC Logging			I. Doneit		2017 - June - 06		Licence/CP: A12345			Block: 7654		Certificate #		Map Attached: Yes													
Activity: Hand felling and grapple yarding															Level of Disturbance (LOD): 3																		
Tree #	Species	Tree Class	Wildlife Value (Low, Mod, High)	Tree Height (m)	Diameter (cm)	Insecurely lodged or hung up limbs/tops = D	Highly unstable tree = D	Recent lean with unstable roots = D	Visual Tree Defects: State S (safe) or D (dangerous) for each defect identified on the tree										RST (radius x 0.3)	AST (cm)	Stem (S or D)	Roots (S or D)	Class 1 Trees = S	Class 2 Trees with no structural defects = S	Class 2 Cedars with low failure potential = S	Class 3 Conifers with no structural defects = S	OVERALL RATING (S or D)	Management					
									LOD = 1			LOD = 2 or 3				LOD = 4												Safe - no action required	Dangerous - fall tree	Dangerous - Install NWZ	Other (remove hazardous part)	Action completed yy/mm/dd	
									HT	DL	WB	ST	SD	SB	CA	CM	TL	RI															From Table 3
1	PI	2M	23	32					S	-	-	?	-	-	-	-	4	S	4.8	7	S	-					S	S					
2	Sx	4H	34	68					D	S	-	-	S	-	D	0	S	10.2	18	S	-					D	S		X				
3	At	2H	24	40					-	S	-	?	-	-	?	0	S	6.0	12	S	-					S	S						
Comments #1 - Dead top; old basal stem damage, drilled AST of 6 & 8; flagged pink (Safe) #2 - Forked top (8m) with crack; large dead limbs (sound); 1 conk (P. pini) at fork; drilled AST of 16, 18, 20 NWZ for tree #2 is 18m radius, flagged 1/2 circle NWZ in Orange print NWZ. #3 - Active cavity nest at 5m; P. tremulae conk at 3m; drilled AST = 10, 12, 14; flagged pink (Safe) & don't disturb tree FS 502a 7530881105 (25/PAK)																																	

The sample field data card illustrates some basic conventions that can be used to consistently document observations and assessment results made during the assessment of wildlife or dangerous trees. In this example, trees were assessed for a manual felling and yarding operation. This activity is recorded as a level of disturbance 3 (LOD-3).

The visual tree assessment details are recorded according the corresponding category of disturbance. If needed, record each defect that is present as either "S" (Safe), "D" (Dangerous), or use a "?" to indicate that the visual hazard rating for the defect is inconclusive and a detailed assessment will be used. For tree lean, consider recording the percentage of lean with a "+" to indicate the lean is away from the worksite, and a "-" to indicate the lean is towards the worksite. Alternatively, one could simply record whether the lean was safe or dangerous according to the hazard criteria associated with the level of disturbance.

Detailed assessment results can be recorded for trees where visual assessment was inconclusive or for trees where a more thorough assessment was made to determine the extent of damage. Record the diameter at sample height (DSH) to correspond to the location where increment cores were taken (DSH).

The overall rating for a tree will be "S" if all defects rate as safe. If any defect is found to be dangerous, then the tree is recorded as "D" for the LOD being assessed. The assessor must then document the management action to be taken. Remember, if the tree is dangerous, the tree must be either removed, have the dangerous defect removed, or the workers protected by installing a No Work Zone. Use the "Comments" section to record other pertinent details about the tree and field marking details.

## Appendix 7. Field Procedure Guides

### Measuring Tree Heights

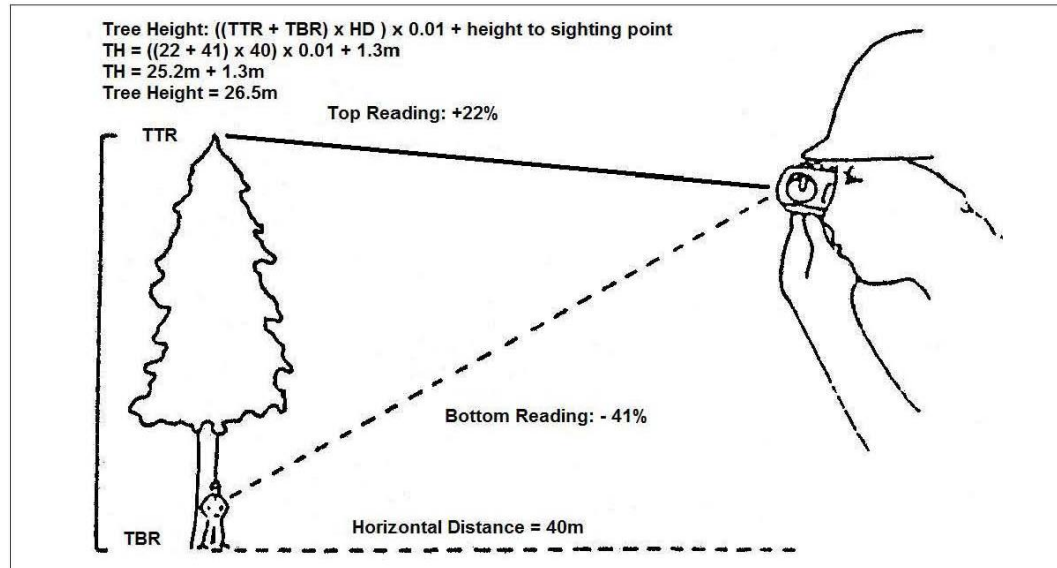

The most common tool for measuring tree height is the Suunto clinometer. The 'clino' works on a pendulum principle and measures the angles to the top and to the base of the tree.

When these measurements are combined with a measured distance to the tree, the height of the tree can be calculated.

The Suunto makes it possible for you to estimate tree height based on two quick readings of the slope lines from your eye to the top and bottom of the tree.

To use the Suunto, hold it to your right eye and watch the internal movable scale, while looking at the target tree with your left eye. Tilt the instrument until you can see the top of the tree, and read the right hand side of the scale (in %). Make note of the reading, then tilt the instrument to the 'base' of the tree (actually, at dbh) and record the reading. Measure the horizontal distance you are from the tree, then calculate the tree height according to the following formula:

$$\text{Tree height} = (TTR + TBR) \times HD \times .01$$

where TTR = Tree top reading (%)

TBR = Tree bottom reading (%) \*

HD = Horizontal distance from tree \*\*

\* Tree bottom readings are usually a negative %; ignore the negative sign and add the bottom % measurement to the top % measurement. In cases where you are looking uphill to sight both the top and bottom of the tree, and both % readings are positive, subtract the tree bottom % reading from the tree top % reading.

\*\* Remember to derive the horizontal distance using slope tables.

## SLOPE CORRECTION TABLE

To get horizontal distance, multiply slope distance by this factor.

Percent Slope (%)	Factor	Percent Slope (%)	Factor	Percent Slope (%)	Factor	Percent Slope (%)	Factor
1	1	26	0.968	51	0.891	76	0.796
2	1	27	0.965	52	0.887	77	0.792
3	1	28	0.963	53	0.884	78	0.789
4	0.999	29	0.960	54	0.880	79	0.785
5	0.999	30	0.958	55	0.876	80	0.781
6	0.998	31	0.955	56	0.873	81	0.777
7	0.998	32	0.952	57	0.869	82	0.773
8	0.997	33	0.950	58	0.865	83	0.769
9	0.996	34	0.947	59	0.861	84	0.766
10	0.995	35	0.944	60	0.857	85	0.762
11	0.994	36	0.941	61	0.854	86	0.758
12	0.993	37	0.938	62	0.850	87	0.754
13	0.992	38	0.935	63	0.846	88	0.751
14	0.99	39	0.932	64	0.842	89	0.747
15	0.989	40	0.928	65	0.838	90	0.743
16	0.987	41	0.925	66	0.835	91	0.740
17	0.986	42	0.922	67	0.831	92	0.736
18	0.984	43	0.919	68	0.827	93	0.732
19	0.982	44	0.915	69	0.823	94	0.729
20	0.981	45	0.912	70	0.819	95	0.725
21	0.979	46	0.908	71	0.815	96	0.721
22	0.977	47	0.905	72	0.812	97	0.718
23	0.975	48	0.902	73	0.808	98	0.714
24	0.972	49	0.898	74	0.804	99	0.711
25	0.97	50	0.894	75	0.800	100	0.707

Source: BC Ministry of Forests and Range, Forest Practices Branch. Aug. 9, 2005. How to Determine Site Index in Silviculture.

## Increment Boring: Field Methods

Increment boring is performed to:

- determine the age of standing trees;
- measure the tree growth rate;
- check for tree defects in stems and roots;
- check chemical penetration of treated wood products;
- test the condition of wooden structures

Your primary field tool will be the increment borer. They are manufactured by several companies (e.g., Haglof, Suunto, Timberline, Mattson), but all contain the same three components (from top to bottom): a handle, a bit, and a core retriever (extractor). They are sold in various bit lengths ranging from 4" to 28" (\$100 to \$500 US). The components nest together for easy packing. When in use, the bit is inserted into the handle and twisted into the tree (always keep the extractor out of the bit and in a safe place while coring).



The tip of the increment borer is threaded to help pull the hollow bit into the tree. Thread styles on the bit may vary from 2 to 3 thread types. The sharpened surface of the leading edge **MUST** be protected from damage at all times. The consequences of a dull bit are varied and can range from mild to extreme. A severely nicked or damaged bit can not be re-sharpened and must be replaced. At \$75 to \$400 per bit, it is best to be careful! The diameter of the core of wood is determined by the inside diameter of the opening of the threaded end of the bit and may range from 5.0 mm to 12.0 mm.

Assemble the coring tool by inserting the bit into the handle and closing the locking mechanism. **BE SURE TO REMOVE THE EXTRACTOR!**

To begin coring, hold the bit just behind the threads and lean into the borer to provide as much body pressure as possible. Slowly turn the bit until the threads have become fully engaged.



After the threads have engaged, you may step back from the increment borer and in a clockwise motion, turn the handle. The bit will proceed into the tree and should be held at a 90 degree angle. Hardwoods (e.g., oak) will require a considerable use of strength and energy. **DO NOT EXTEND THE HANDLE TO GAIN LEVERAGE OR USE A POWER DRILL!**

If you hit a rot pocket (you will know immediately because of the ease of turning), back out immediately or else your bit may be incredibly difficult to remove (the threads do not engage in reverse unless they already have a bite in the wood).



Your goal is to core the tree slightly past the pith (center) of the stem. To gauge your depth at any given time, you can hold the extractor up to the side of the tree (it is the same length as the bit and will inform you of your progress).





When the proper depth has been achieved, back the bit out one full turn, then insert the extractor with the edges turned upside down (∩) into the hollow increment corer bit, at a slight angle applying upward pressure. Insert the extractor to its full length (depending upon the species, this may require that you apply some pressure with the heel of your hand near the end). NEVER drive the extractor in with a hammer or other implement.

Then turn handle ½ turn backwards, causing the extractor edges to point

up (∪). SLOWLY withdraw the extractor from the increment handle and you should retrieve an intact core with the serrated tip holding it in place. Remove your borer from the tree as soon as possible to prevent it from being "frozen" in the tree. Current wisdom suggests that the hole you left will scar over quickly and no attempt should be made to treat or plug the hole with any type of substance or object. Just leave it be. If you experienced twisting or breaking of the cores, try cleaning and oiling the borer bit (inside and out). Some follow this practice every few cores to reduce core problems.



Immediately place the core into a paper drinking straw, seal the ends, and mark the straw with the sample ID number (this should code to your field data sheets that contain additional information about the tree and site). Be sure not to loose any pieces. If the core breaks, maintain the order of the pieces in the straw. Store the straws in a protective container while in the field (such as a map tube).

Shown here is a collection of basic field tools you will need. They include the INCREMENT BORER, PAPER STRAWS (for core storage), INDELIBLE MARKER PEN, MASKING TAPE (for joining two or more straws together for long cores), BEESWAX (to rub on borer tip to facilitate boring), 2 WOODEN DOWEL RODS and a RUBBER MALLET (to free pieces of wood that may become entrapped in borer bit--this is a pretty common occurrence). A wooden golf tee works well for dislodging material at the tip of the borer bit.

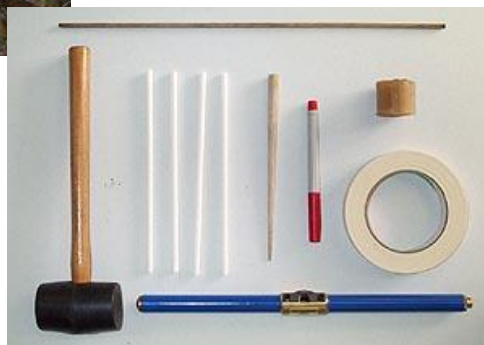



You should always keep a cleaning kit within easy reach (field or lab). Use a cleaning rod designed for .22 caliber rifles with a plastic tip insert that holds either some steel wool or a small cotton pad (both of which should be soaked in WD-40 or equivalent spray lubricant and rust preventative). All bits should be sprayed with WD-40 inside and out prior to storage and minimally after every day of use. Cleaning the bits after every few trees to ensure untwisted & unbroken increment cores is a good idea. Store and transport the bit inside the handle with a plastic cap over its end.

Source: WDTAC – Ministry of Transportation and Highways. 2003.



British Columbia Tree Code List					
<b>NATIVE CONIFERS</b>			<b>NATIVE HARDWOODS</b>		
Cedar	Thuja	C	Alder	Alnus	D
western redcedar	<i>T. plicata</i>	Cw	red alder	<i>A. rubra</i>	Dr
Cypress	Chamaecyparis	Y	Apple	Malus	U
yellow-cedar	<i>C. nootkatensis</i>	Yc	Pacific crab apple	<i>M. fusca</i>	Up
Douglas-fir	Pseudotsuga	F	Arbutus	Arbutus	R
Douglas-fir	<i>P. menziesii</i>	Fd	Arbutus	<i>A. menziesii</i>	Ra
coastal Douglas-fir	<i>P. menziesii</i> var. <i>menziesii</i>	Fdc	Aspen, Cottonwood, Populus		
interior Douglas-fir	<i>P. menziesii</i> var. <i>glauca</i>	Fdi	or Poplar		
Fir (Balsam)	Abies	B	poplar	<i>P. balsamifera</i>	Ac
amabilis fir	<i>A. amabilis</i>	Ba	balsam poplar	<i>P. b. ssp. balsamifera</i>	Acb
grand fir	<i>A. grandis</i>	Bg	black cottonwood	<i>P. b. ssp. trichocarpa</i>	Act
subalpine fir	<i>A. lasiocarpa</i>	Bl	hybrid poplars	<i>P. spp.</i>	Ax
Hemlock	Tsuga	H	trembling aspen	<i>P. tremuloides</i>	At
mountain hemlock	<i>T. mertensiana</i>	Hm	Birch	Betula	E
western hemlock	<i>T. heterophylla</i>	Hw	Alaska paper birch	<i>B. neoalaskana</i>	Ea
mountain x western	<i>T. mertensiana</i> x		Alaska x paper		
Hxm	<i>heterophylla</i>		birch hybrid	<i>B. x winteri</i>	Exp
hemlock hybrid	<i>heterophylla</i>		paper birch	<i>B. papyrifera</i>	Ep
Juniper	Juniperus	J	water birch	<i>B. occidentalis</i>	EW
Rocky Mtn. juniper	<i>J. scopulorum</i>	Jr	Cascara	Rhamnus	K
Larch	Larix	L	cascara	<i>R. purshiana</i>	Kc
alpine larch	<i>L. laricina</i>	La	Cherry	Prunus	V
tamarack	<i>L. laricina</i>	Lt	bitter cherry	<i>P. emarginata</i>	Vb
western larch	<i>L. occidentalis</i>	Lw	choke cherry	<i>P. virginiana</i>	Vv
Pine	Pinus	P	pin cherry	<i>P. pensylvanica</i>	Vp
jack pine	<i>P. banksiana</i>	Pj	Dogwood	Cornus	G
limber pine	<i>P. flexilis</i>	Pf	Pacific dogwood	<i>C. nuttallii</i>	Gp
lodgepole pine	<i>P. contorta</i>	Pl	Maple	Acer	M
lodgepole pine	<i>P. contorta</i> var. <i>latifolia</i>	Pli	bigleaf maple	<i>A. macrophyllum</i>	Mb
lodgepole x jack	<i>P. x murraybanksiana</i>	Pxj	vine maple	<i>A. circinatum</i>	Mv
pine hybrid			Oak	Quercus	Q
ponderosa pine	<i>P. ponderosa</i>	Py	Garry oak	<i>Q. garryana</i>	Qg
shore pine	<i>P. contorta</i> var. <i>contorta</i>	Pic	Willow	Salix	W
western white pine	<i>P. monticola</i>	Pw	Bebb's willow	<i>S. bebbiana</i>	Wb
whitebark pine	<i>P. albicaulis</i>	Pa	Pacific willow	<i>S. lucida</i>	Wp
Spruce	Picea	S	peachleaf willow	<i>S. amygdaloides</i>	Wa
black spruce	<i>P. mariana</i>	Sb	pussy willow	<i>S. discolor</i>	Wd
Engelmann spruce	<i>P. engelmannii</i>	Se	Scouler's willow	<i>S. scouleriana</i>	Ws
Sitka spruce	<i>P. sitchensis</i>	Ss	Sitka willow	<i>S. sitchensis</i>	Wt
white spruce	<i>P. glauca</i>	Sw	UNKNOWN		X
spruce hybrid	<i>Picea</i> cross	Sx	Unknown		Xc
Engelmann x white	<i>P. engelmannii</i> x <i>glauca</i>	Sxw	Unknown conifer		Xh
Sitka x white	<i>P. x lutzii</i>	Sxl	Unknown hardwood		
Sitka x unknown	<i>P. sitchensis</i> x ?	Sxs	OTHERS		
hybrid			Other tree, not on list		Z
Yew	Taxus	T	Other conifer		Zc
western yew	<i>T. brevifolia</i>	Tw	Other hardwood		Zh

